

# 500 G.P.M. 912 SERIES

## 50 HERTZ ELECTRIC MOTOR DRIVE

**SIZE : 4-481-11D/ 4-483-11D      MODEL: 480      IMPELLER : Enclosed      R. P. M. : 2950**

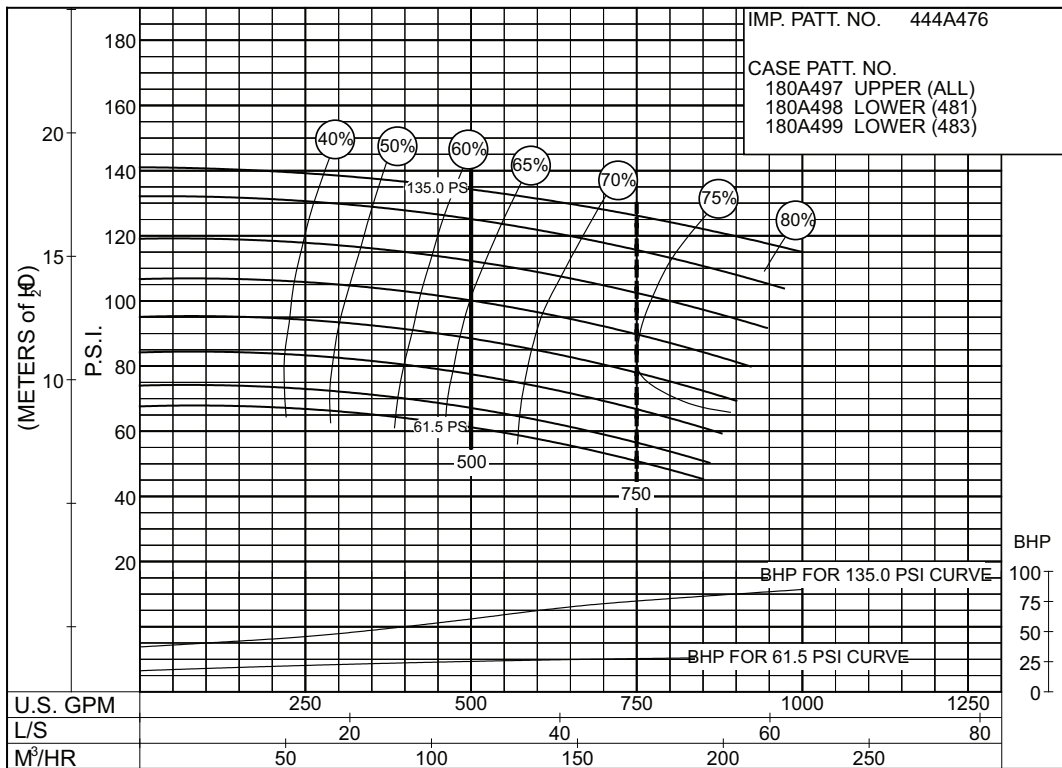

**61 to 134 P.S.I.**

**PC-193678**

**SIZE : 5-485-12      MODEL: 480      IMPELLER : Enclosed      R. P. M. : 2950**

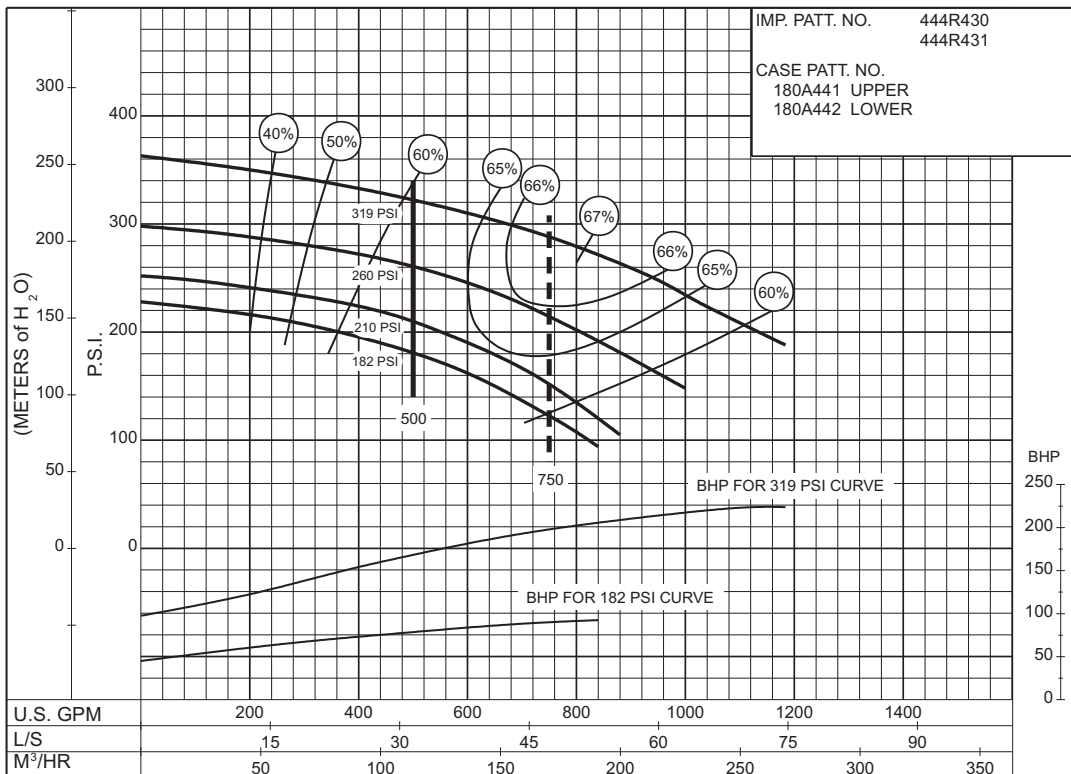

**180 to 320 P.S.I.**

**PC-174443**



**AURORA®**

**500 G.P.M. 912 SERIES**

**50 HERTZ ELECTRIC MOTOR DRIVE**

**SIZE: 6"-1923F**

**MODEL: 1900**

**IMPELLER : Enclosed**

**R. P. M. : 2950**

IMP. PATT. NO. 444S490 & 444S491  
 CASE PATT. NO. Upper Patt. No : 180A511  
 Lower Patt. No : 180A512

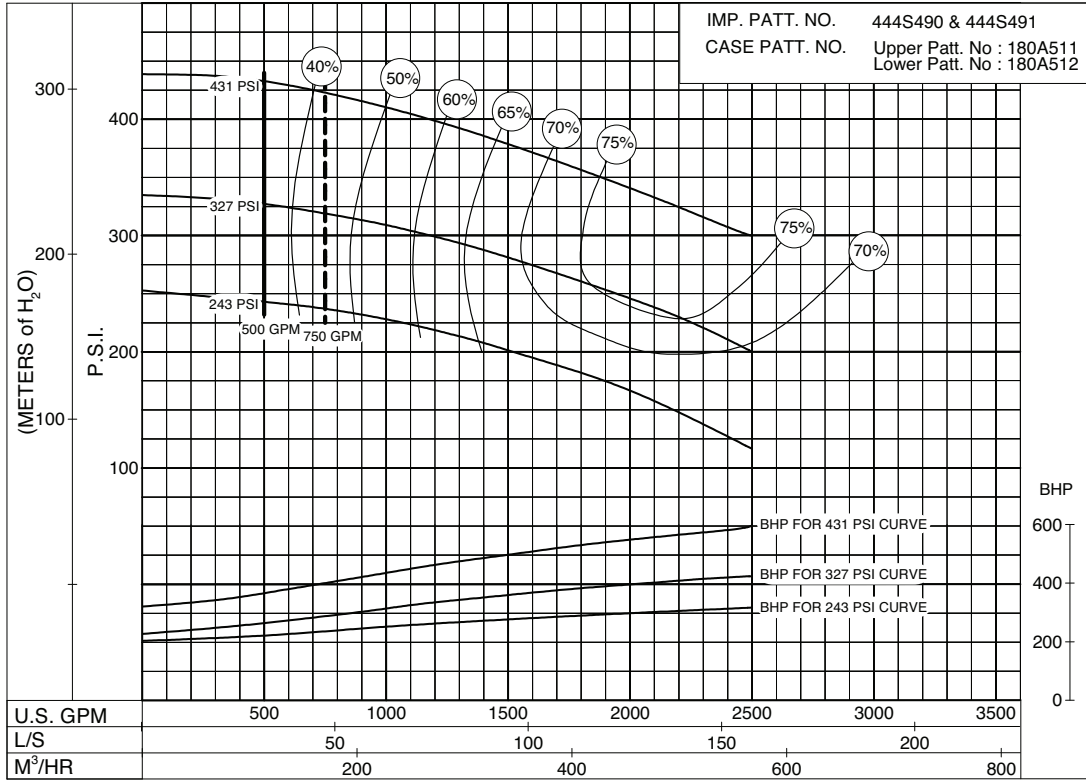

**243  
to  
431  
P.S.I.**

**PC-201248**

THIS PAGE LEFT INTENTIONALLY BLANK

# 500 G.P.M. 912 SERIES

## 50 HERTZ ELECTRIC MOTOR DRIVE

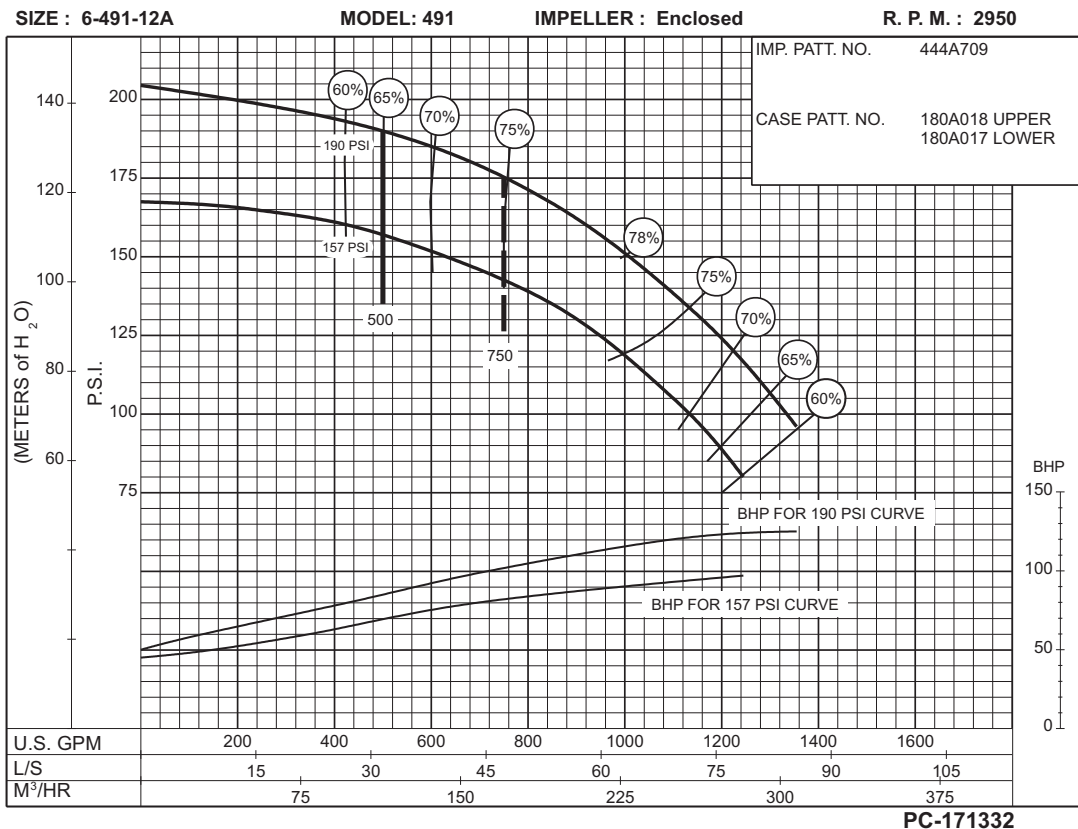
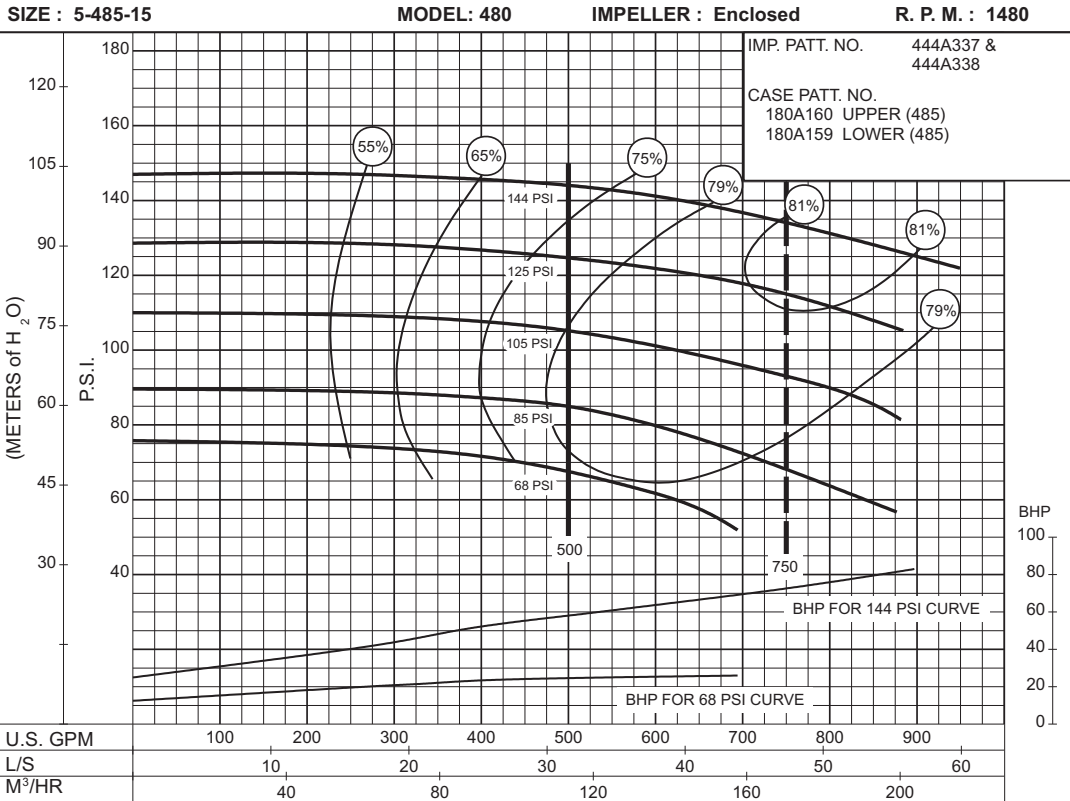

# 750 G.P.M. 912 SERIES

## 50 HERTZ ELECTRIC MOTOR DRIVE

SIZE : 4-491-8A

MODEL: 491

IMPELLER : Enclosed

R. P. M. : 3000

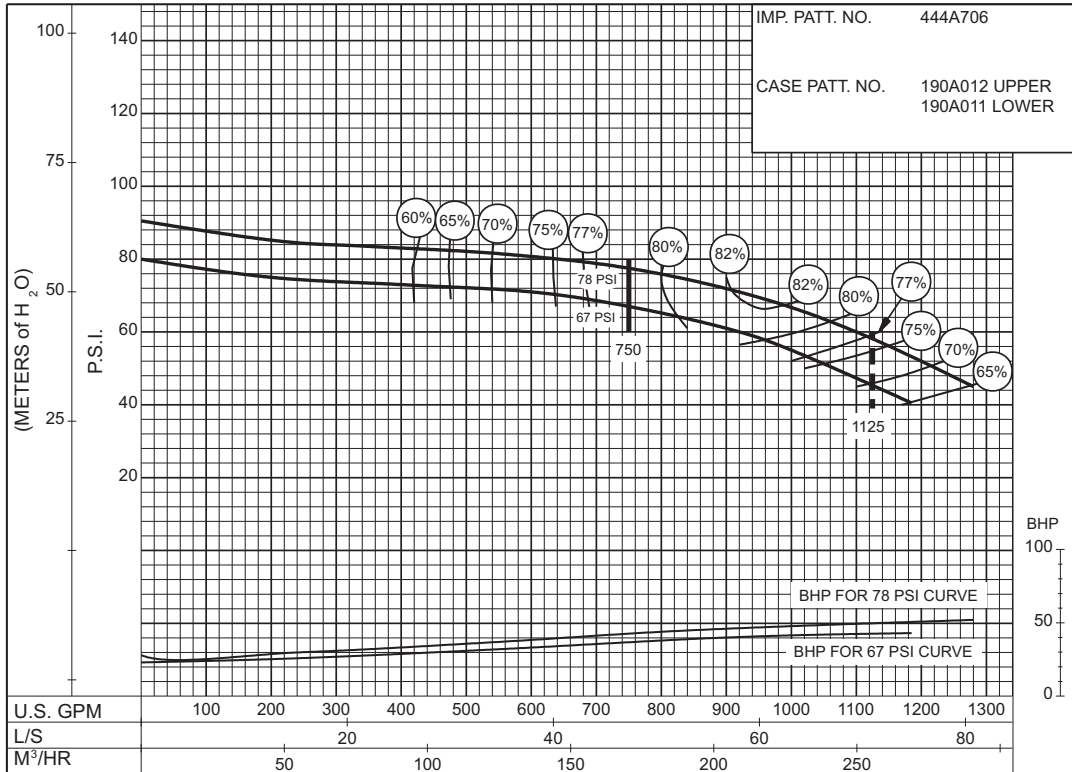

**67 to 78 P.S.I.**

PC-171333

SIZE : 6-485-17A

MODEL: 480

IMPELLER : Enclosed

R. P. M. : 1480

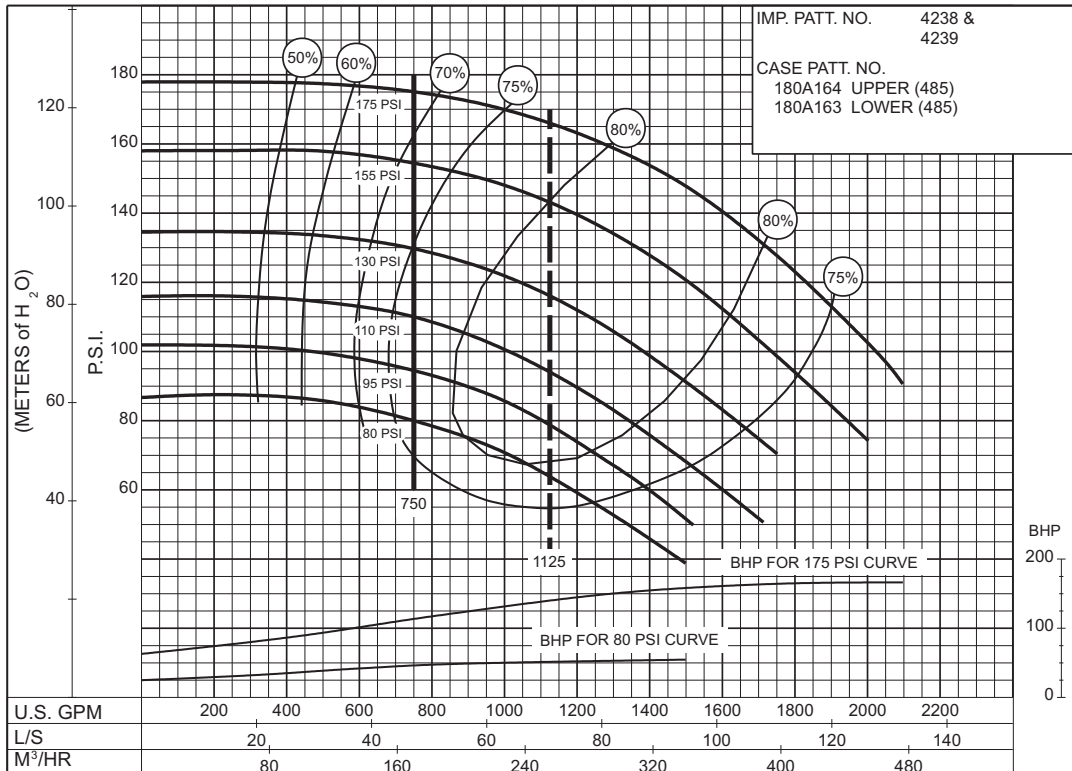

**80 to 175 P.S.I.**

PC-147570A



AURORA®

# 750 G.P.M. 912 SERIES

## 50 HERTZ ELECTRIC MOTOR DRIVE

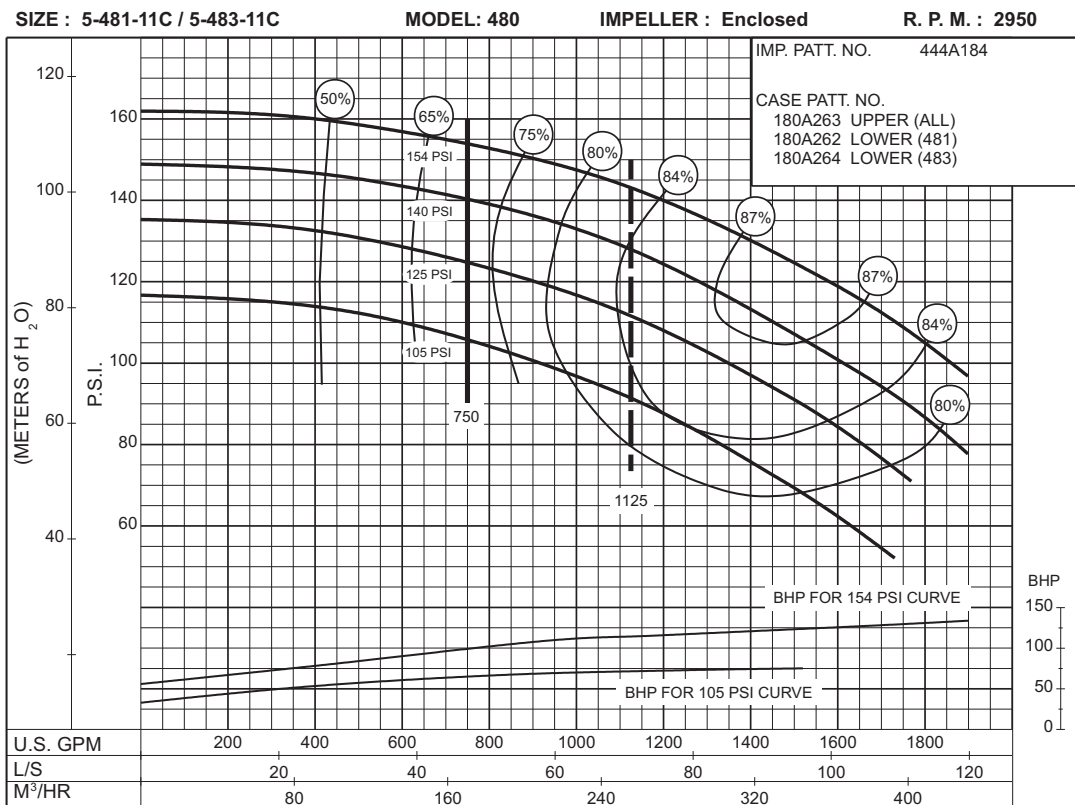
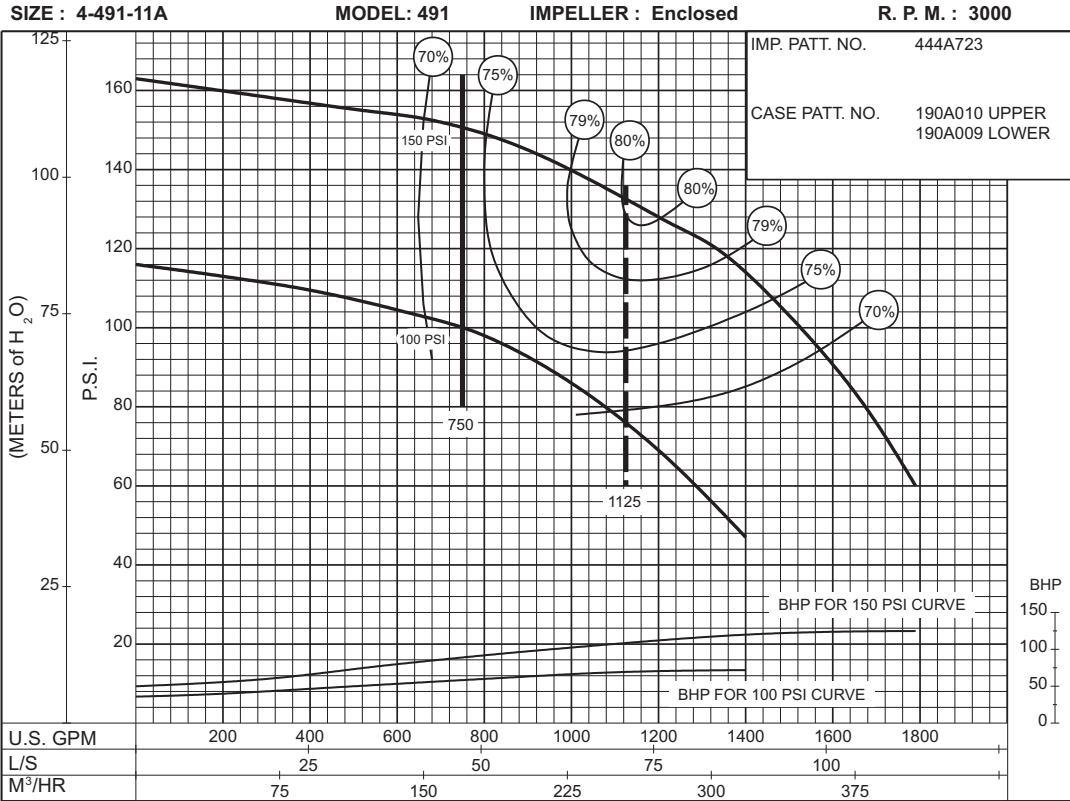

# 750 G.P.M. 912 SERIES

## 50 HERTZ ELECTRIC MOTOR DRIVE

SIZE : 6-491-12A

MODEL: 491

IMPELLER : Enclosed

R. P. M. : 2950

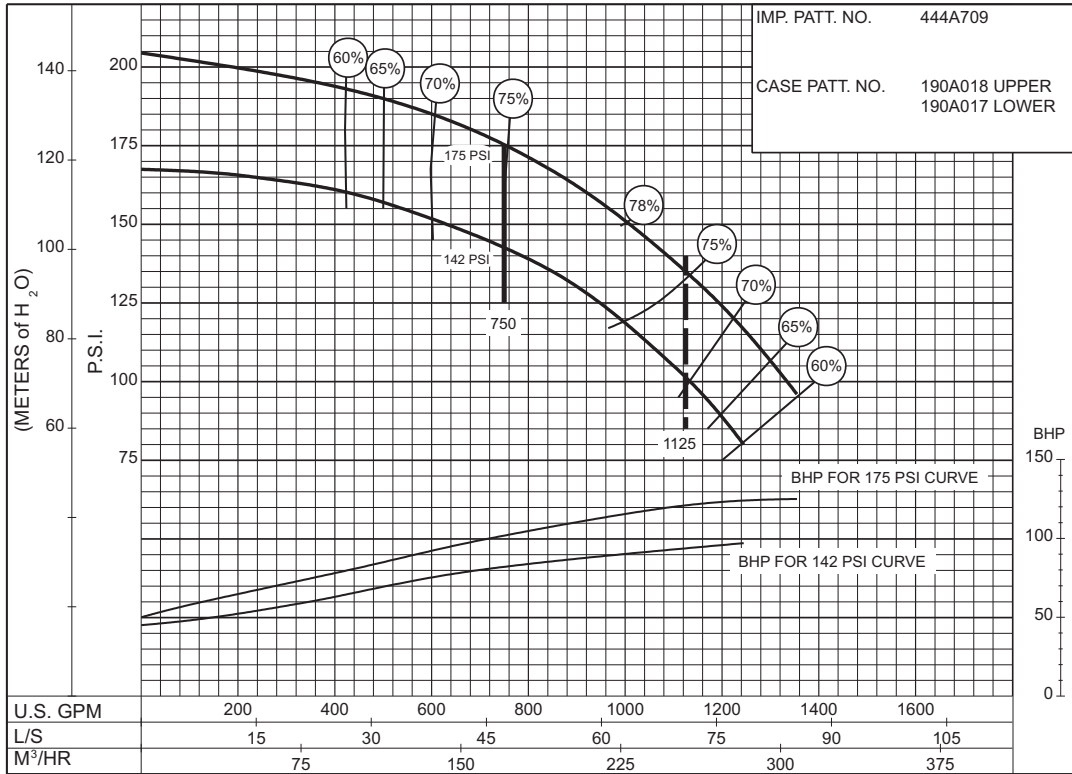

**142 to 175 P.S.I.**

PC-171335

SIZE : 6-485-12

MODEL: 480

IMPELLER : Enclosed

R. P. M. : 2950

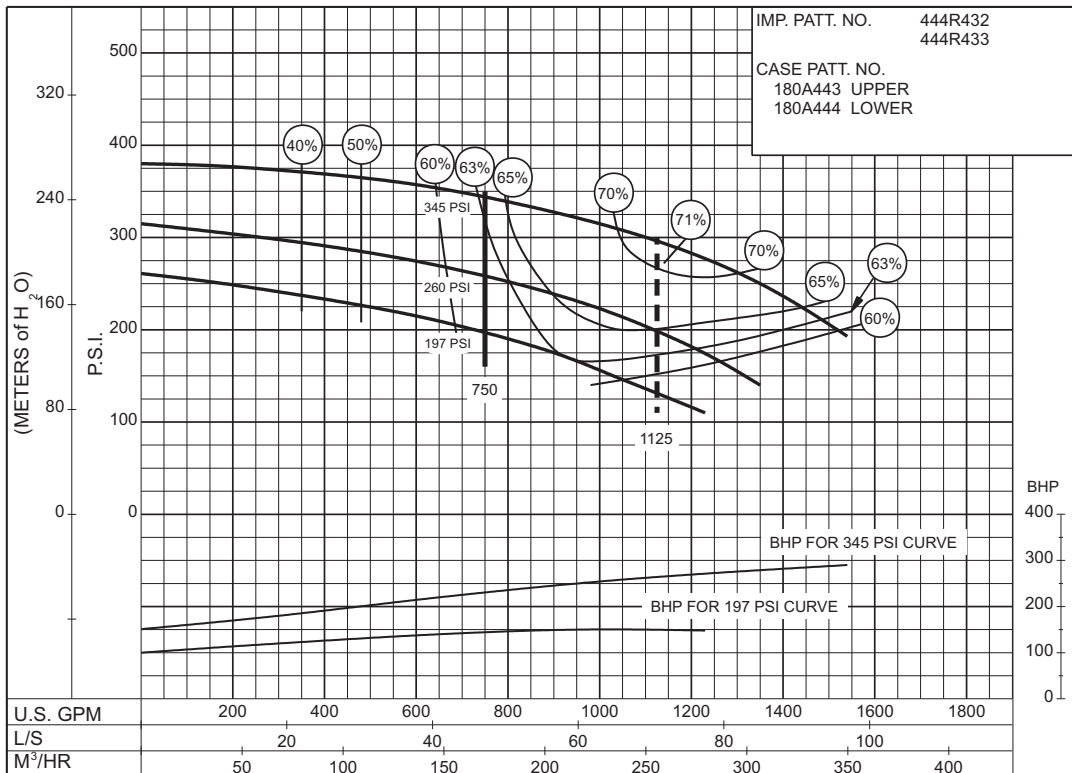

**197 to 345 P.S.I.**

PC-174446



**AURORA®**

**750 G.P.M. 912 SERIES**  
**50 HERTZ ELECTRIC MOTOR DRIVE**

**SIZE: 6-485-16**

**MODEL: 485**

**IMPELLER : Enclosed**

**R. P. M. : 2950**

IMP. PATT. NO. 444S490 & 444S491  
 CASE PATT. NO. Upper Patt. No : 180A511  
 Lower Patt. No : 180A512

**237  
to  
421  
P.S.I.**

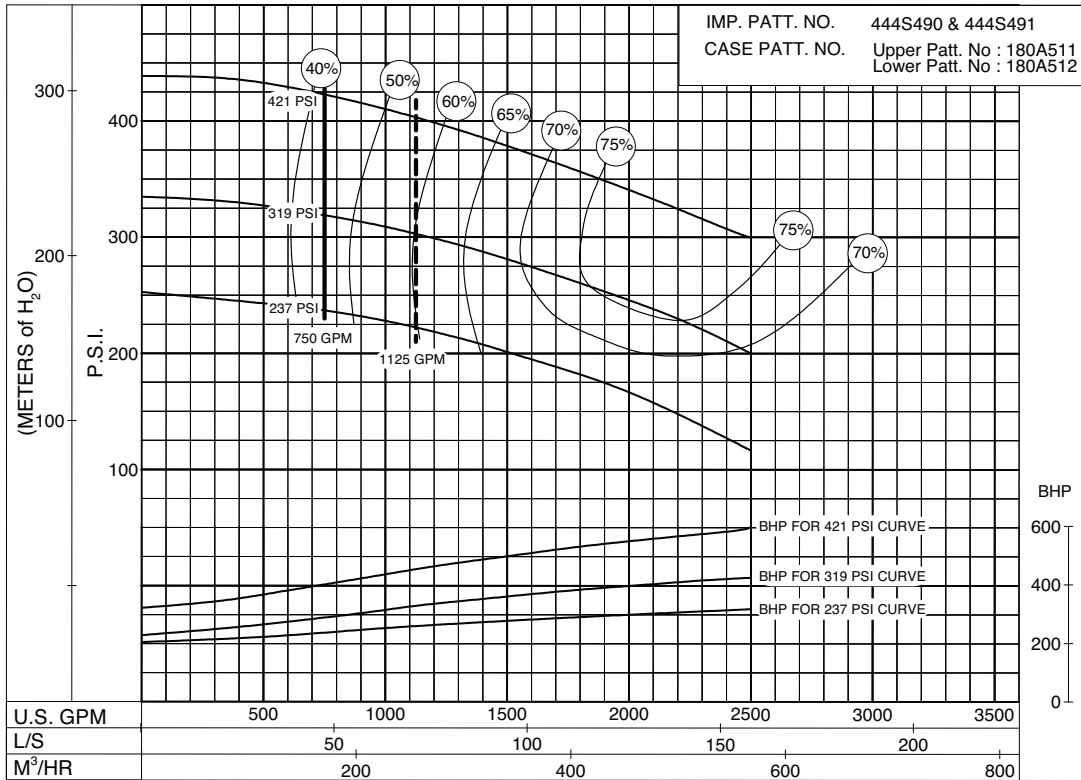

**PC-200268A**

**247  
to  
435  
P.S.I.**

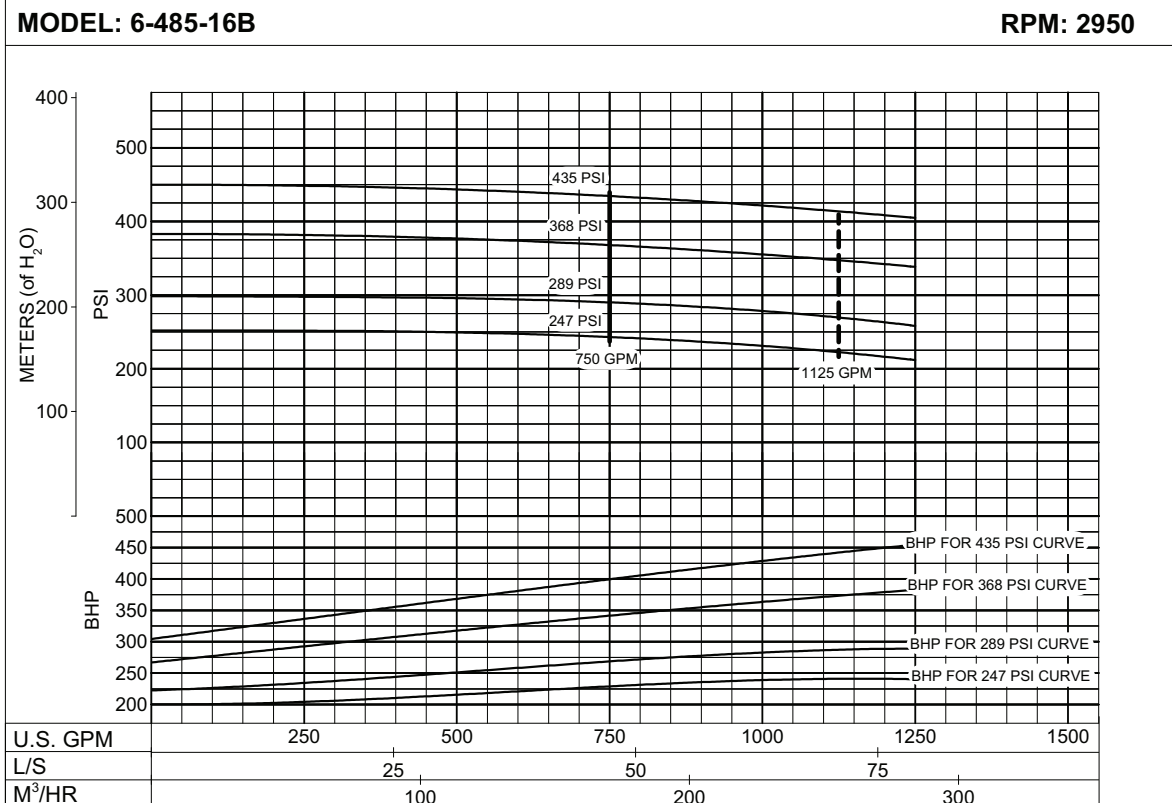

**PC-204637A**



THIS PAGE LEFT INTENTIONALLY BLANK

**1000 G.P.M. 912 SERIES**  
**50 HERTZ ELECTRIC MOTOR DRIVE**

SIZE : 6-481-18C / 6-483-18C

MODEL: 480

IMPELLER : Enclosed

R. P. M. : 1480

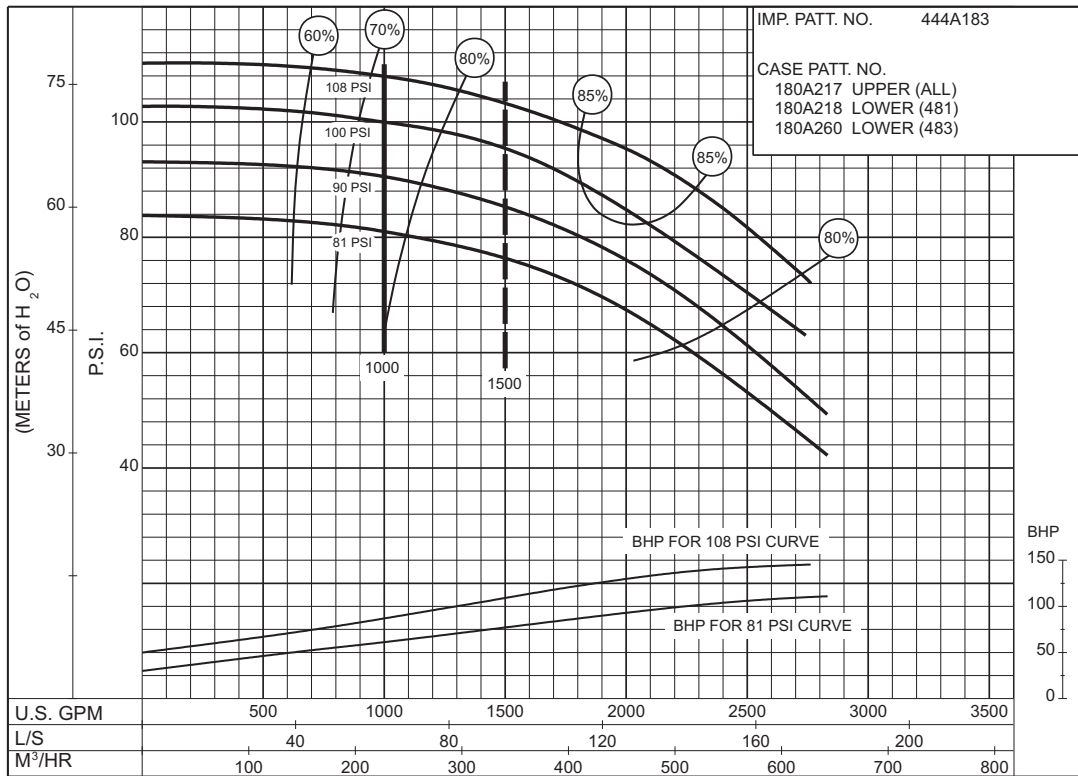

**81  
to  
108  
P.S.I.**

PC-147574A

# 1000 G.P.M. 912 SERIES

## 50 HERTZ ELECTRIC MOTOR DRIVE

SIZE : 5-492-10

MODEL: 491

IMPELLER : Enclosed

R. P. M. : 3000

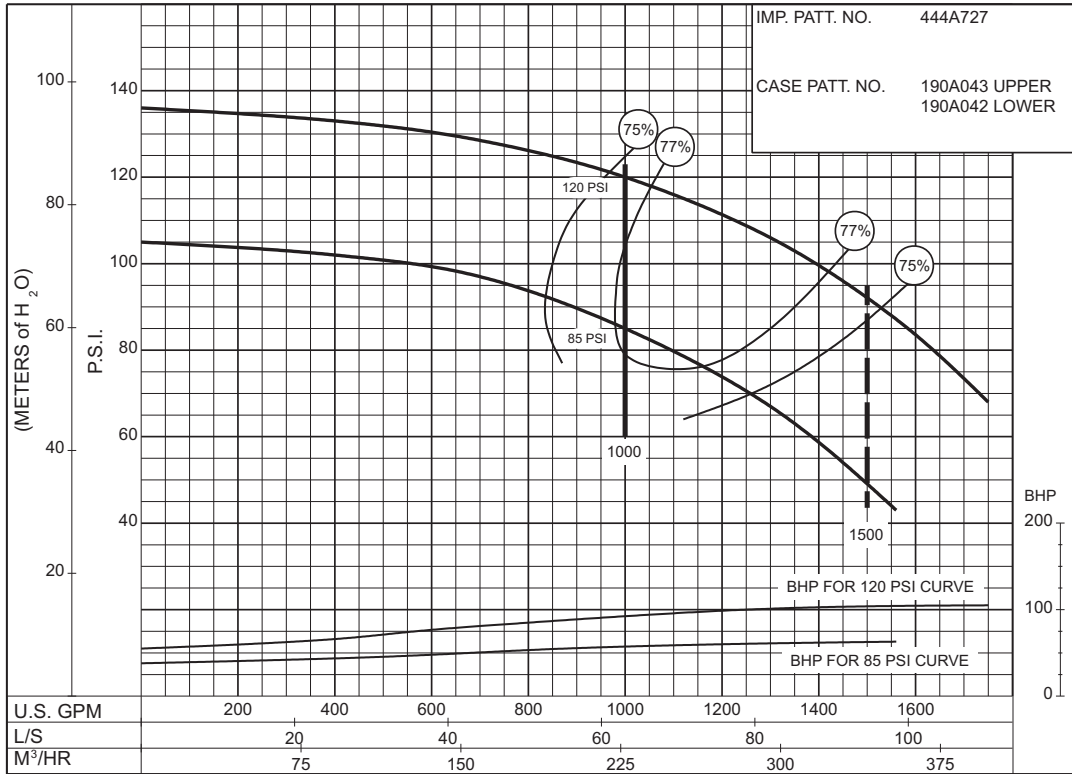

PC-171336

**85 to 120 P.S.I.**

SIZE : 5-481-11C / 5-483-11C

MODEL: 480

IMPELLER : Enclosed

R. P. M. : 2950

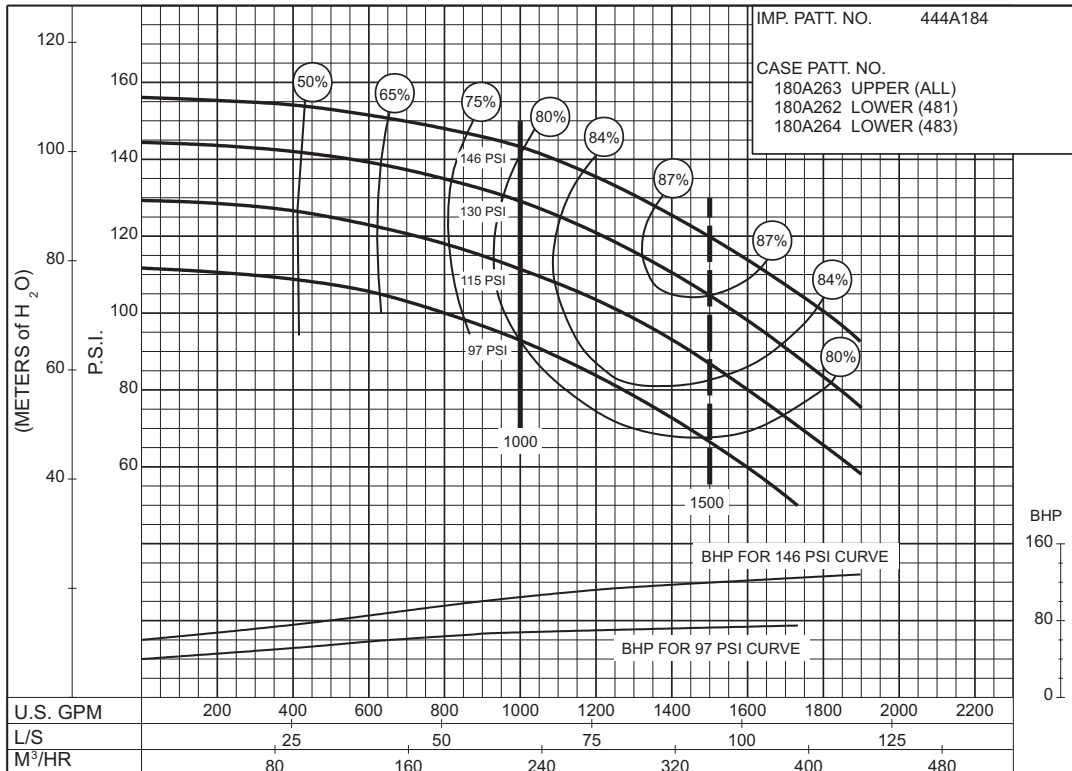

PC-147572A

**97 to 146 P.S.I.**

Section **912** Page **609.10**

Date **April 2000**

Supersedes Section 912 Page 609.1

THIS PAGE LEFT INTENTIONALLY BLANK

# 1000 G.P.M. 912 SERIES

## 50 HERTZ ELECTRIC MOTOR DRIVE

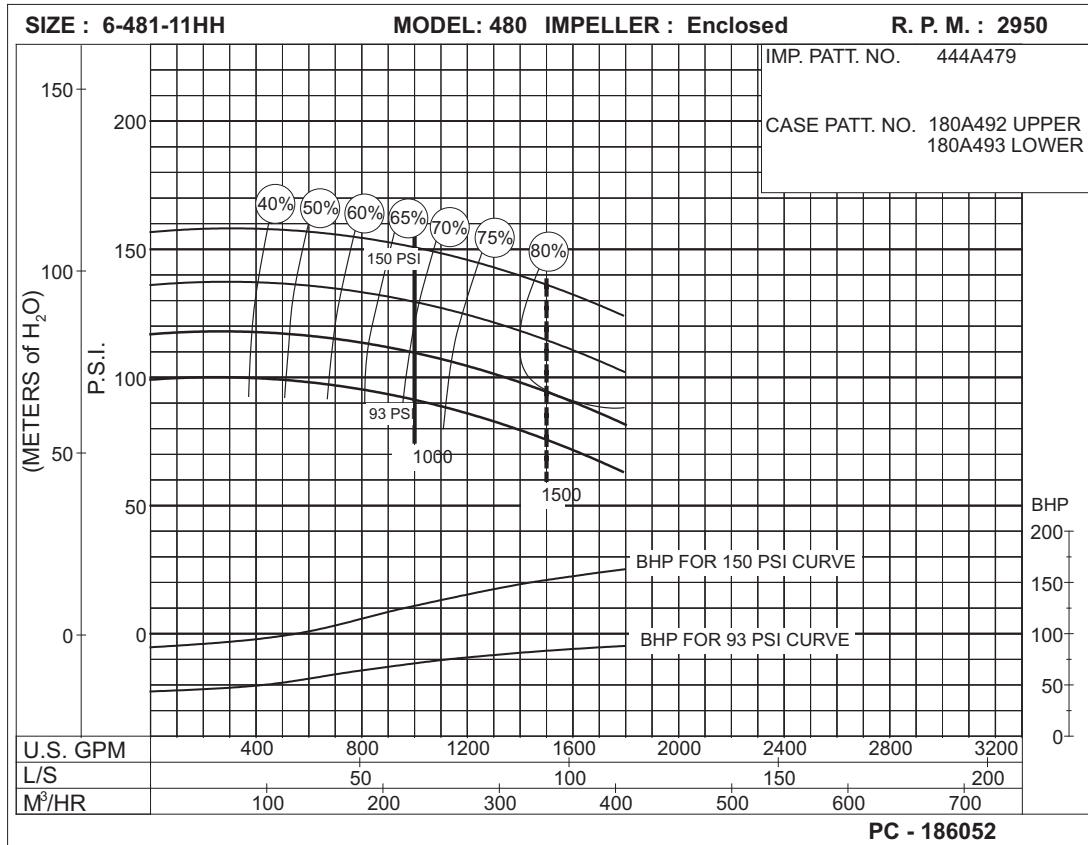

**93 to 150 P.S.I.**

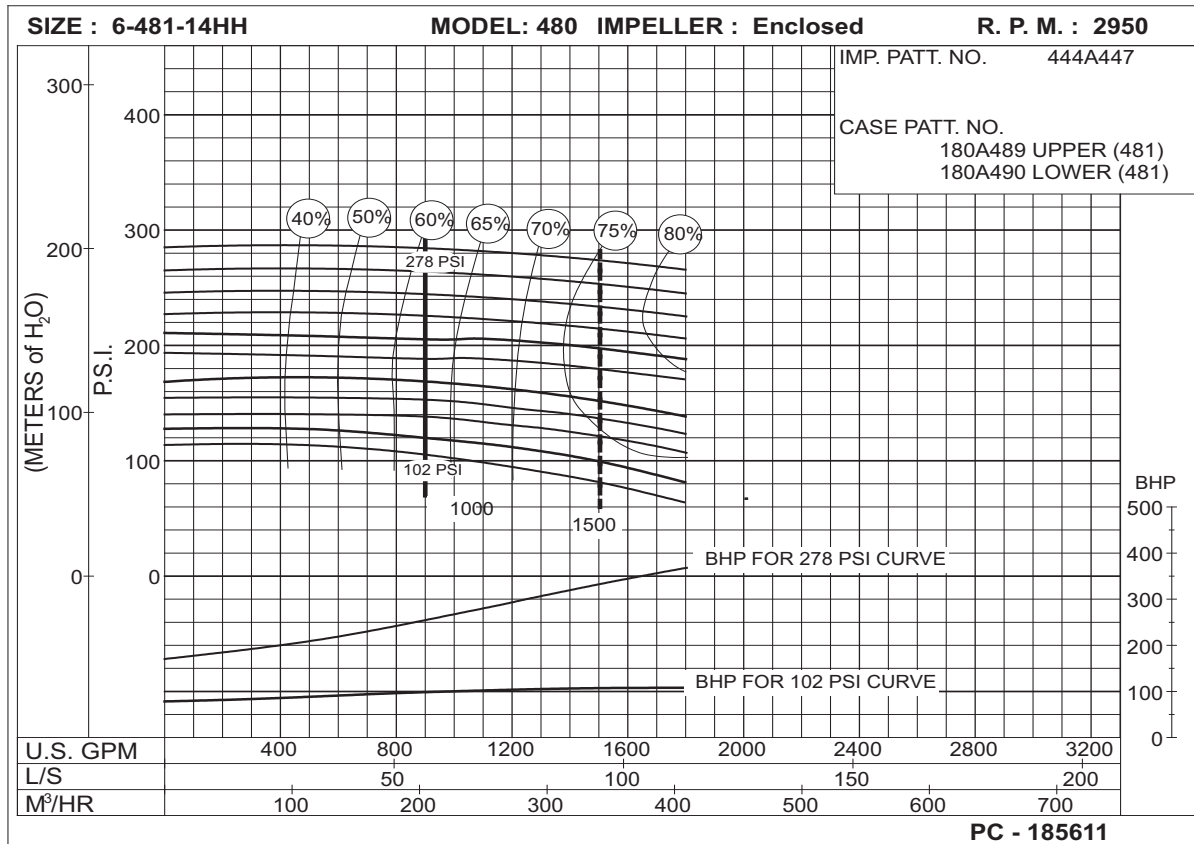

**102 to 278 P.S.I.**

**1000 G.P.M. 912 SERIES**  
**50 HERTZ ELECTRIC MOTOR DRIVE**

**SIZE: 6-485-16**

**MODEL: 485**

**IMPELLER : Enclosed**

**R. P. M. : 2950**

IMP. PATT. NO. 444S490 & 444S491  
 CASE PATT. NO. Upper Patt. No : 180A511  
 Lower Patt. No : 180A512

**228  
to  
405  
P.S.I.**

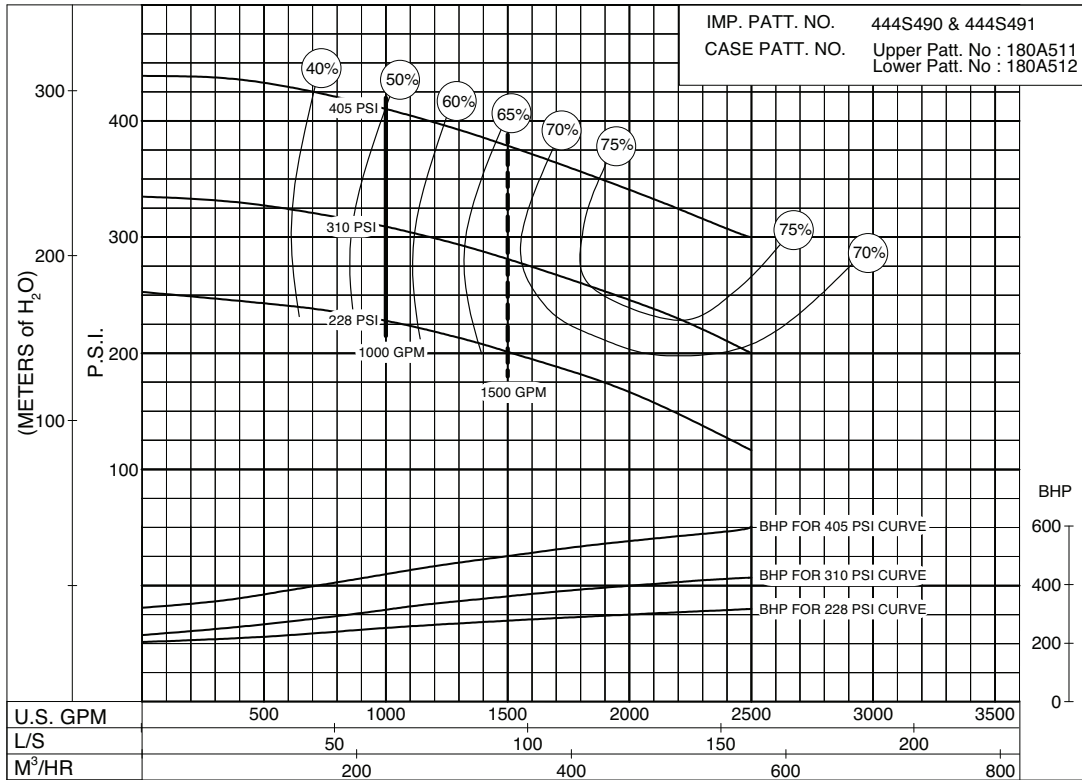

**PC-200269A**

**234  
to  
425  
P.S.I.**

**MODEL: 6-485-16B**

**RPM: 2950**

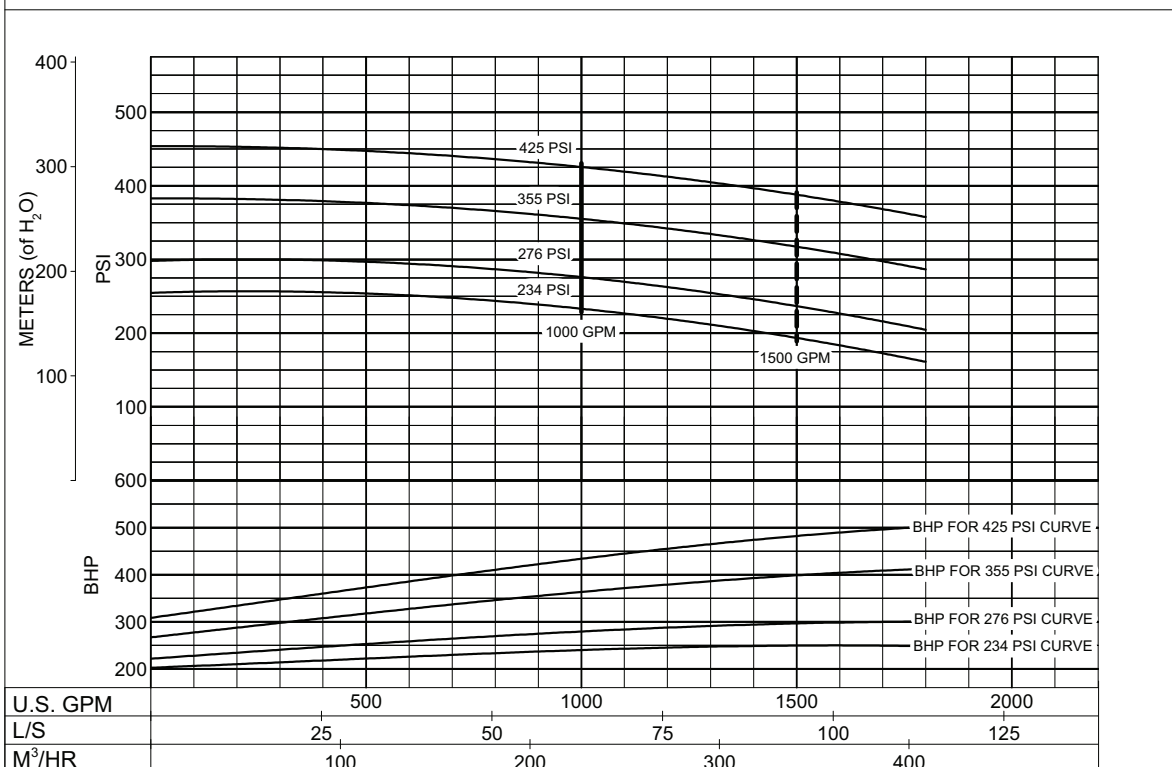

**PC-204638A**

# 1250 G.P.M. 912 SERIES

## 50 HERTZ ELECTRIC MOTOR DRIVE

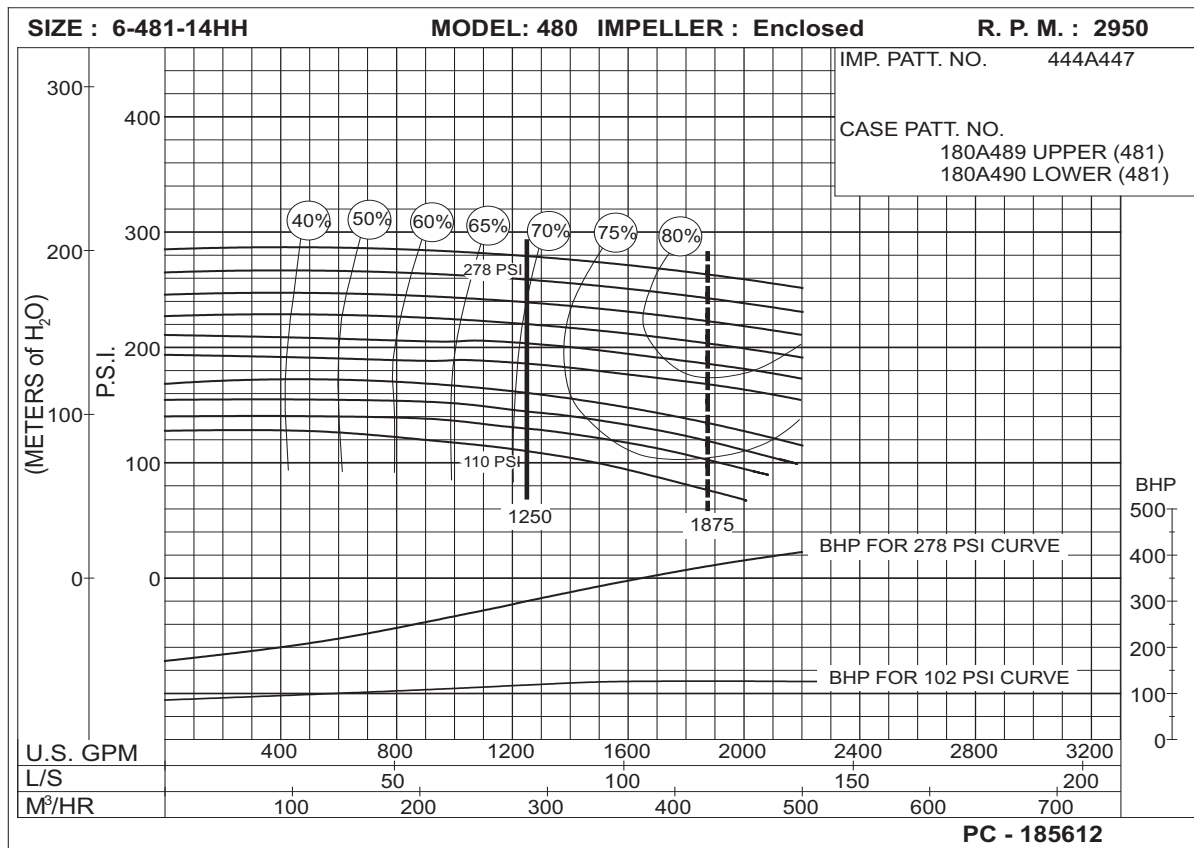
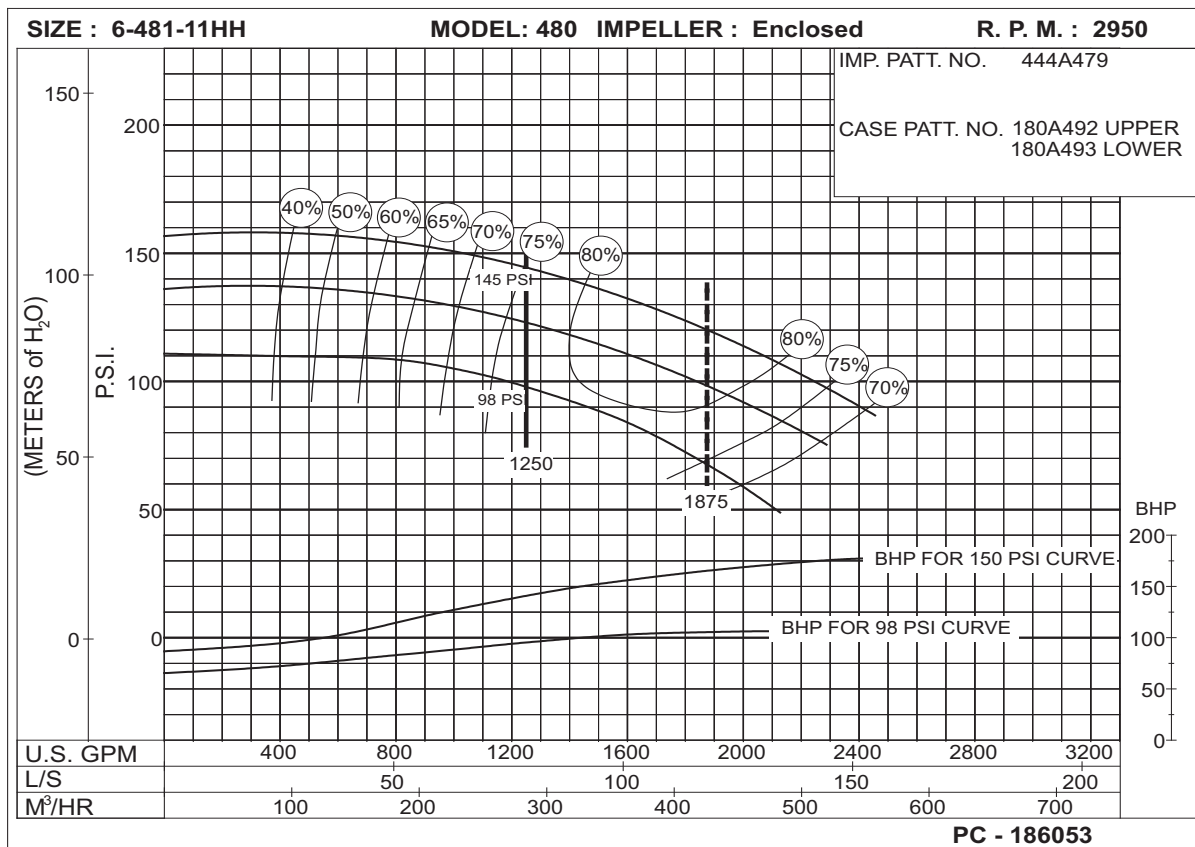

**1250 G.P.M. 912 SERIES**  
**50 HERTZ ELECTRIC MOTOR DRIVE**

**SIZE: 6-485-16**

**MODEL: 485**

**IMPELLER : Enclosed**

**R. P. M. : 2950**

IMP. PATT. NO. 444S490 & 444S491  
 CASE PATT. NO. Upper Patt. No : 180A511  
 Lower Patt. No : 180A512

**216  
to  
390  
P.S.I.**

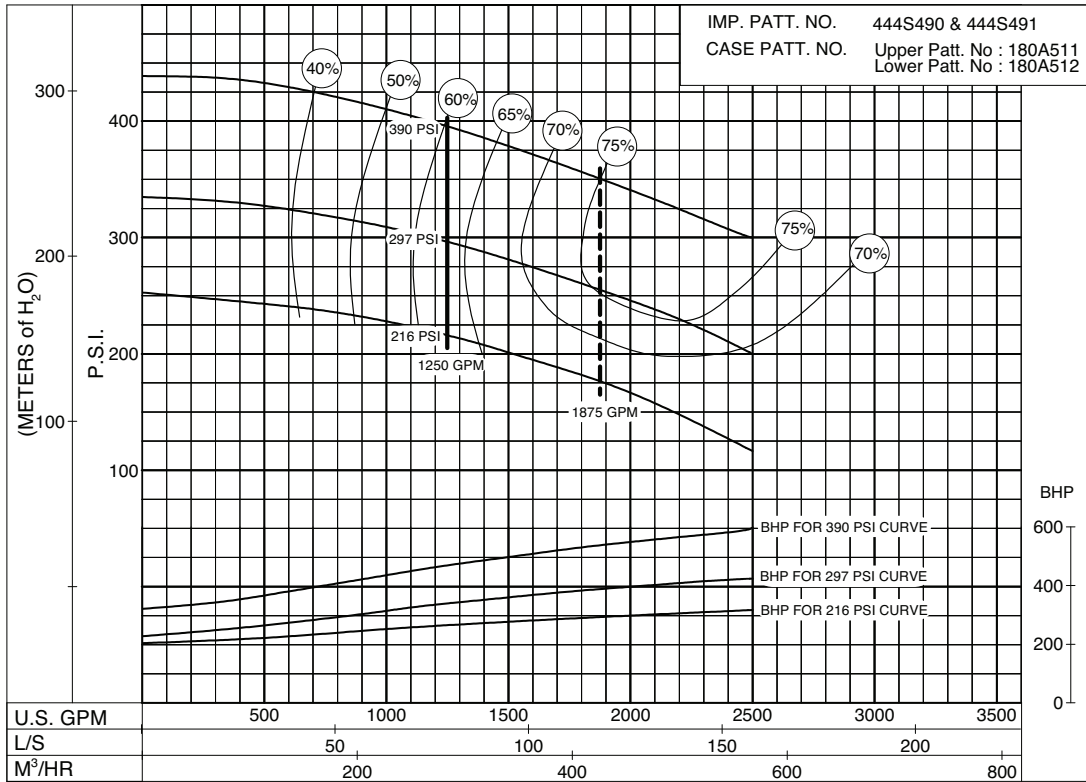

**PC-200270A**

**259  
to  
410  
P.S.I.**

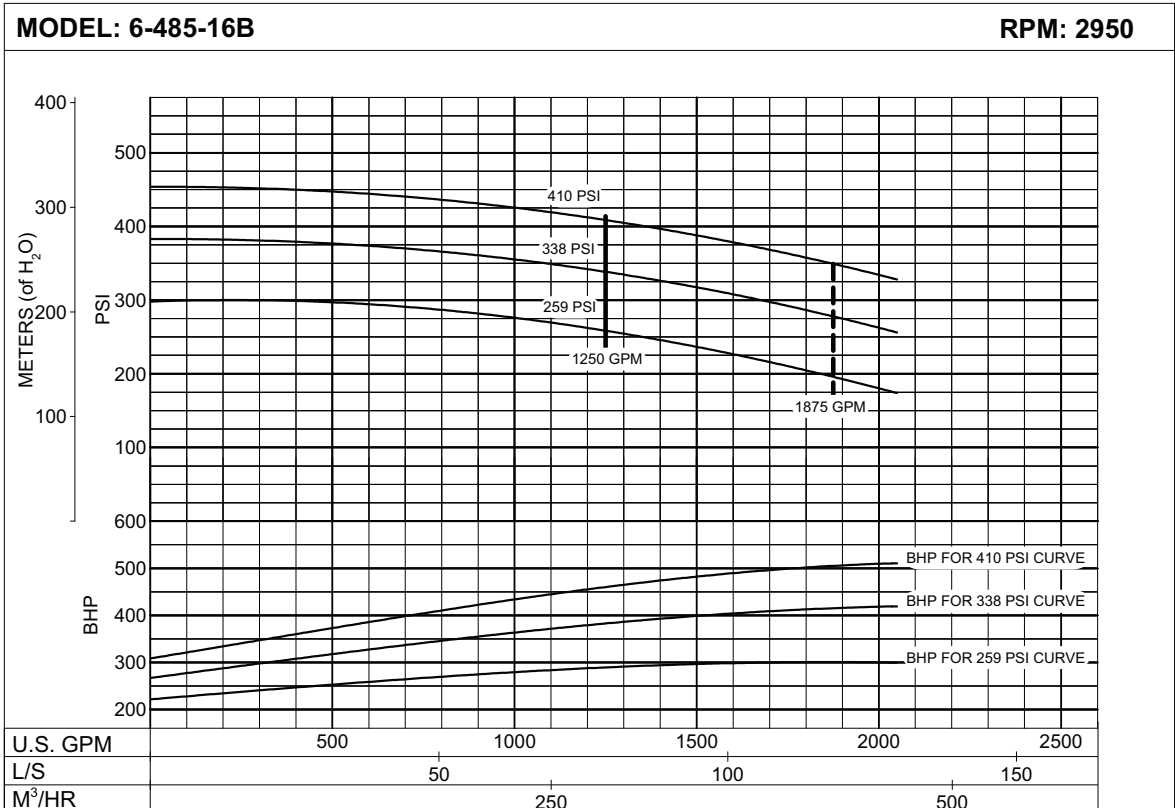

**PC-204639A**



# 1250 G.P.M. 912 SERIES

## 50 HERTZ ELECTRIC MOTOR DRIVE

SIZE : 6-481-18C / 6-483-18C

MODEL: 480

IMPELLER : Enclosed

R. P. M. : 1480

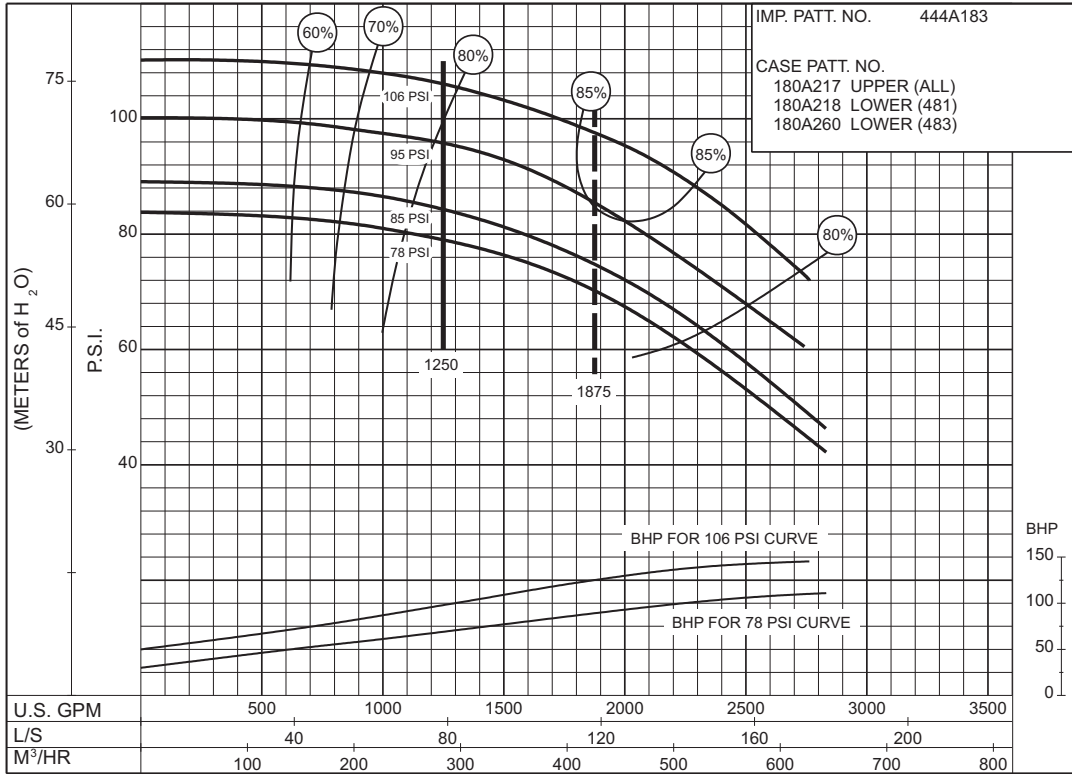

PC-147578A

**78 to 106 P.S.I.**

SIZE : 8-481-21

MODEL: 480

IMPELLER : Enclosed

R. P. M. : 1480

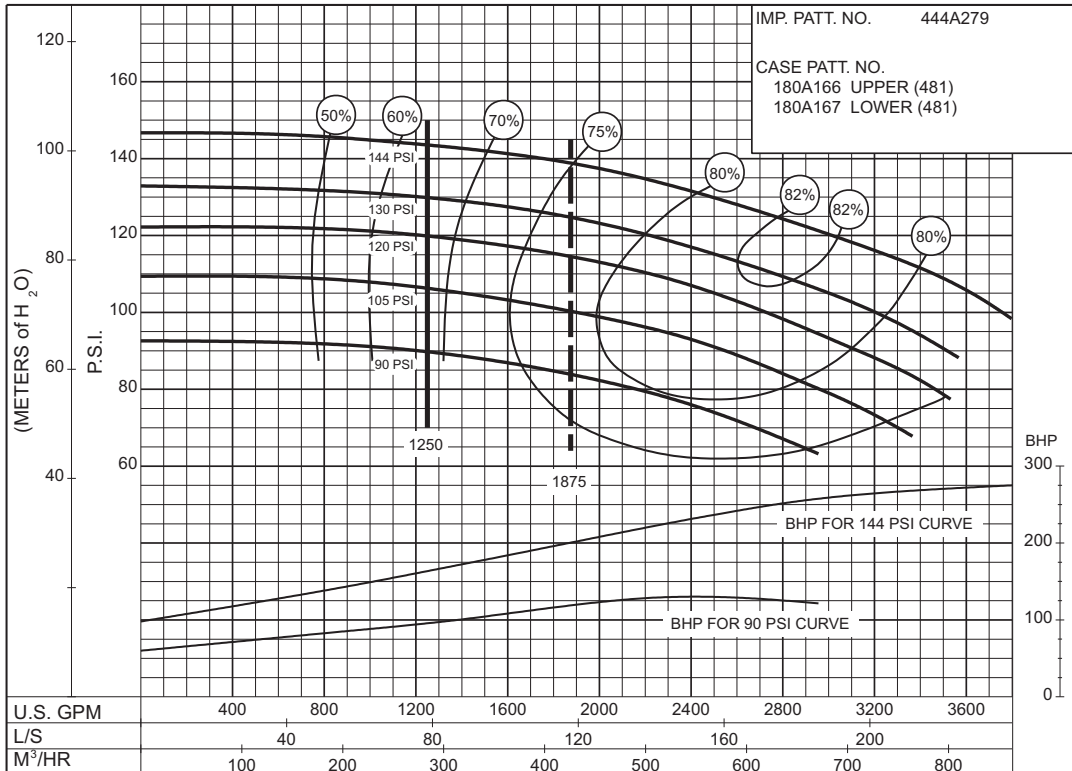

PC-147576A

**90 to 144 P.S.I.**

**1500 G.P.M. 912 SERIES**  
**50 HERTZ ELECTRIC MOTOR DRIVE**

**121  
to  
137  
P.S.I.**

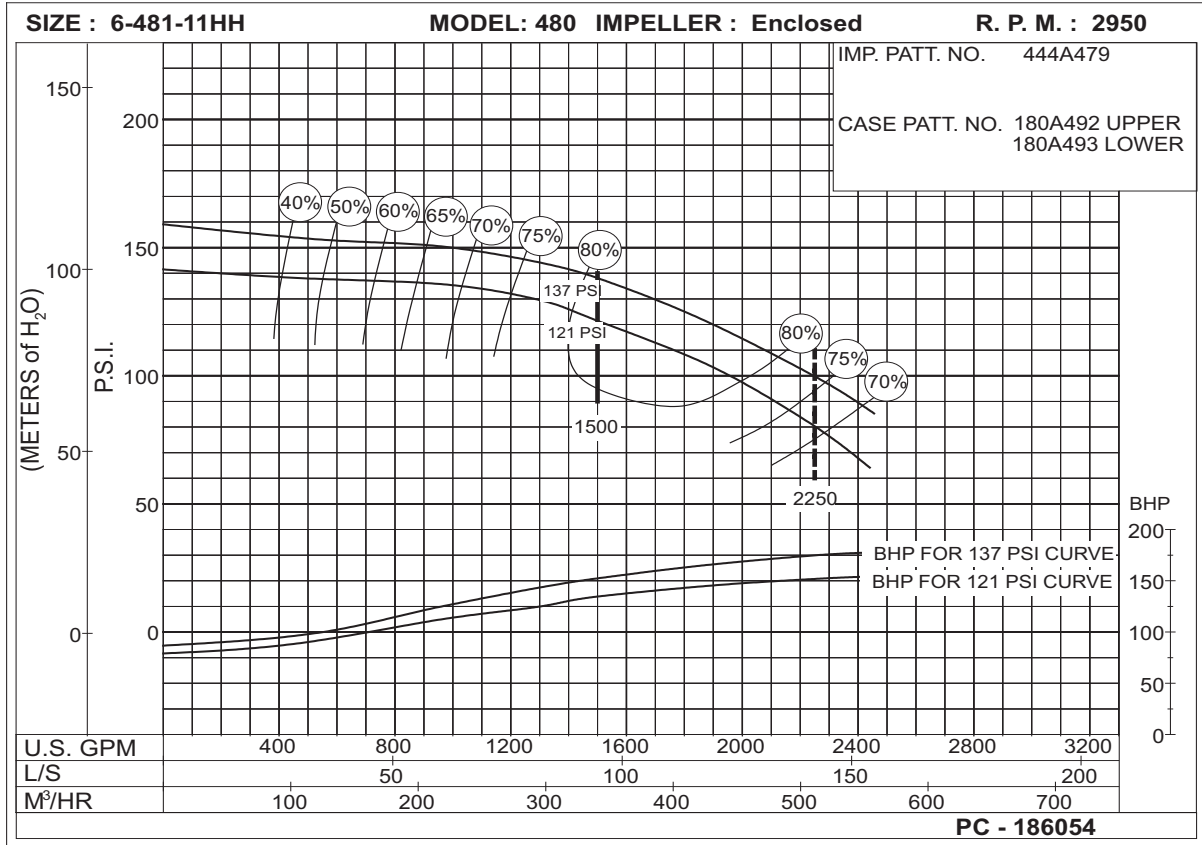

**110  
to  
275  
P.S.I.**

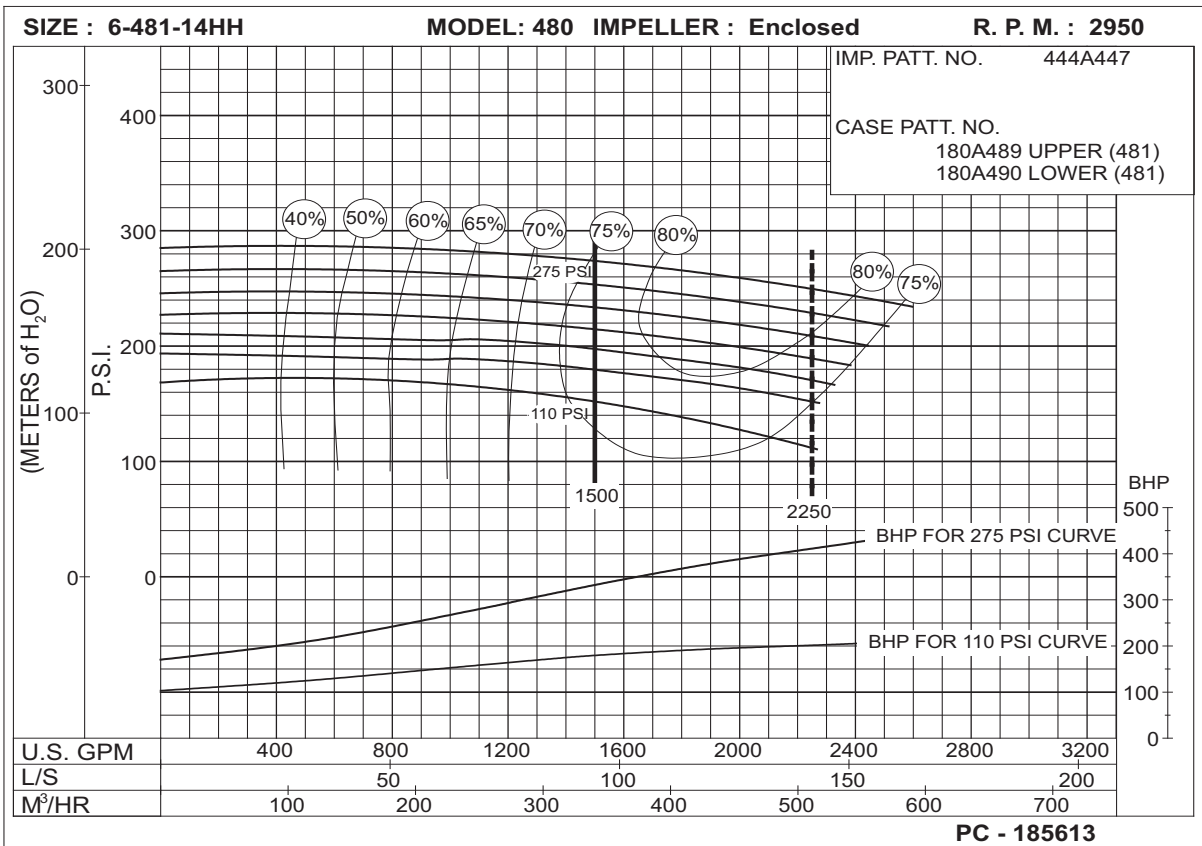

# 1500 G.P.M. 912 SERIES

## 50 HERTZ ELECTRIC MOTOR DRIVE

SIZE: 6-485-16

MODEL: 485

IMPELLER : Enclosed

R. P. M. : 2950

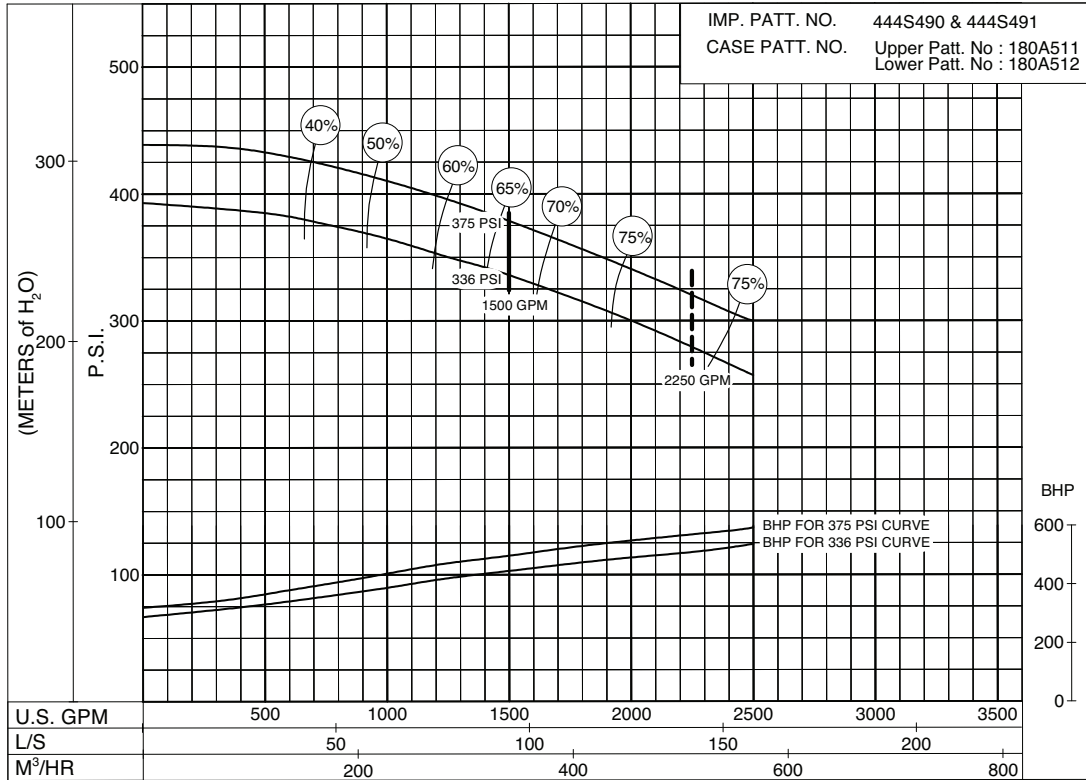

PC-200271A

Section **912** Page **612.3**

Date **October 1, 2008**

Supersedes Section 912 Page 612.3

THIS PAGE LEFT INTENTIONALLY BLANK

# 1500 G.P.M. 912 SERIES

## 50 HERTZ ELECTRIC MOTOR DRIVE

SIZE : 6-481-18C / 6-483-18C

MODEL: 480

IMPELLER : Enclosed

R. P. M. : 1480

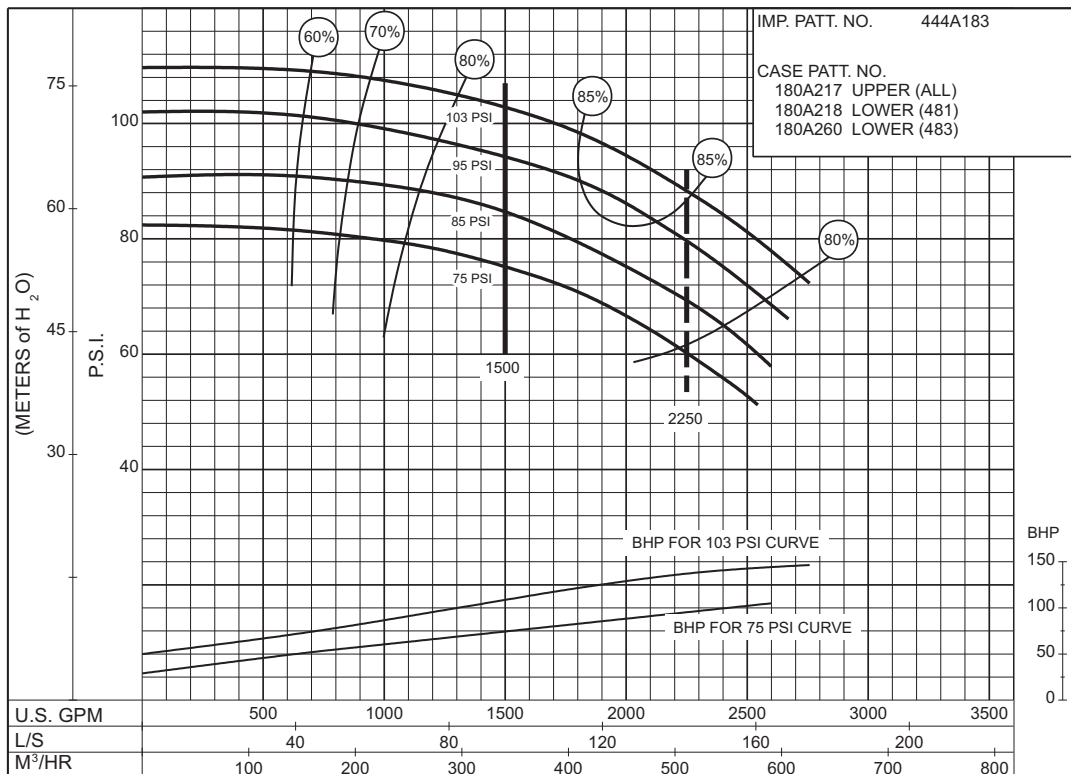

**75 to 103 P.S.I.**

PC-147582A

SIZE : 6-492-10

MODEL: 492

IMPELLER : Enclosed

R. P. M. : 3000

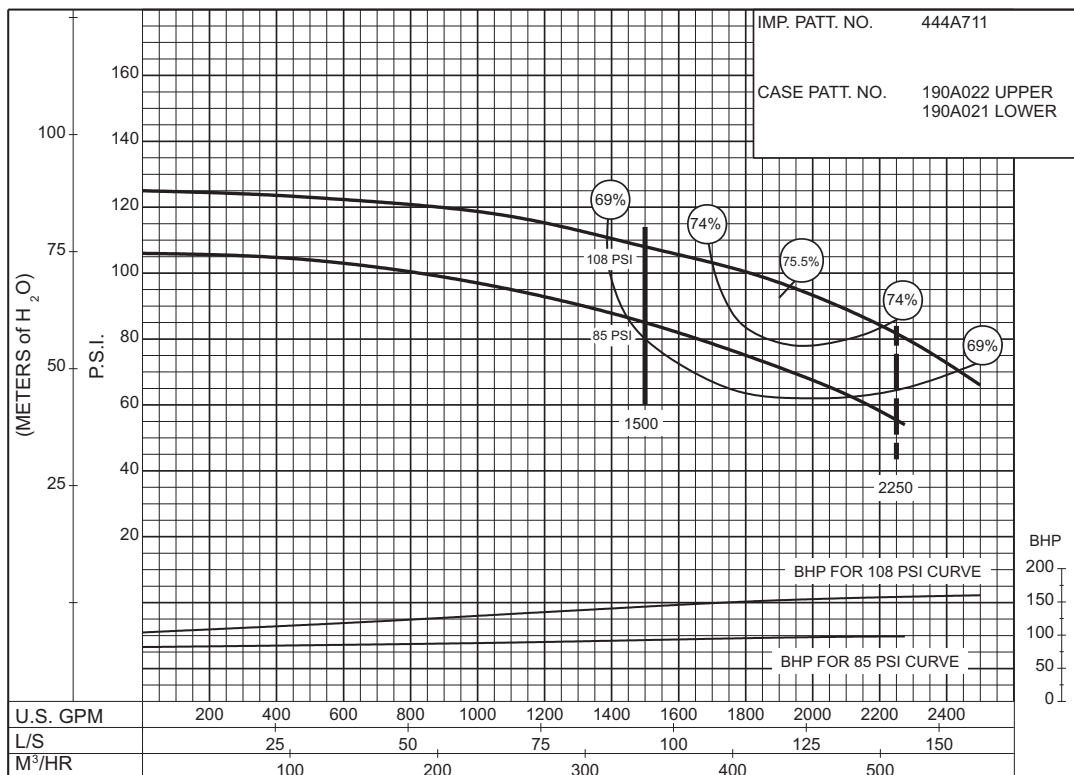

**85 to 108 P.S.I.**

PC-171337



**AURORA®**

# 1500 G.P.M. 912 SERIES 50 HERTZ ELECTRIC MOTOR DRIVE

SIZE : 8-481-21

MODEL: 480

IMPELLER : Enclosed

R. P. M. : 1480

IMP. PATT. NO. 444A279

CASE PATT. NO.  
180A166 UPPER (ALL)  
180A167 LOWER (481)

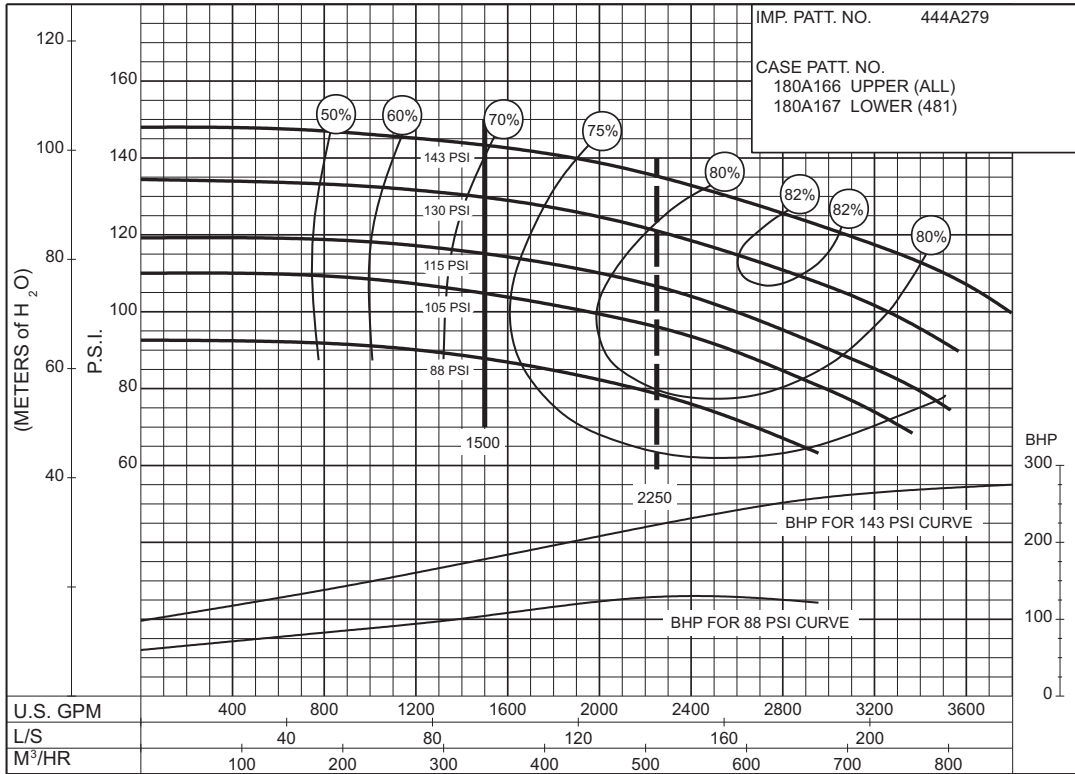

PC-147580A

88  
to  
143  
P.S.I.

# 2000 G.P.M. 912 SERIES

## 50 HERTZ ELECTRIC MOTOR DRIVE

SIZE : 8-481-17B / 8-483-17B

MODEL: 480

IMPELLER : Enclosed

R. P. M. : 1480

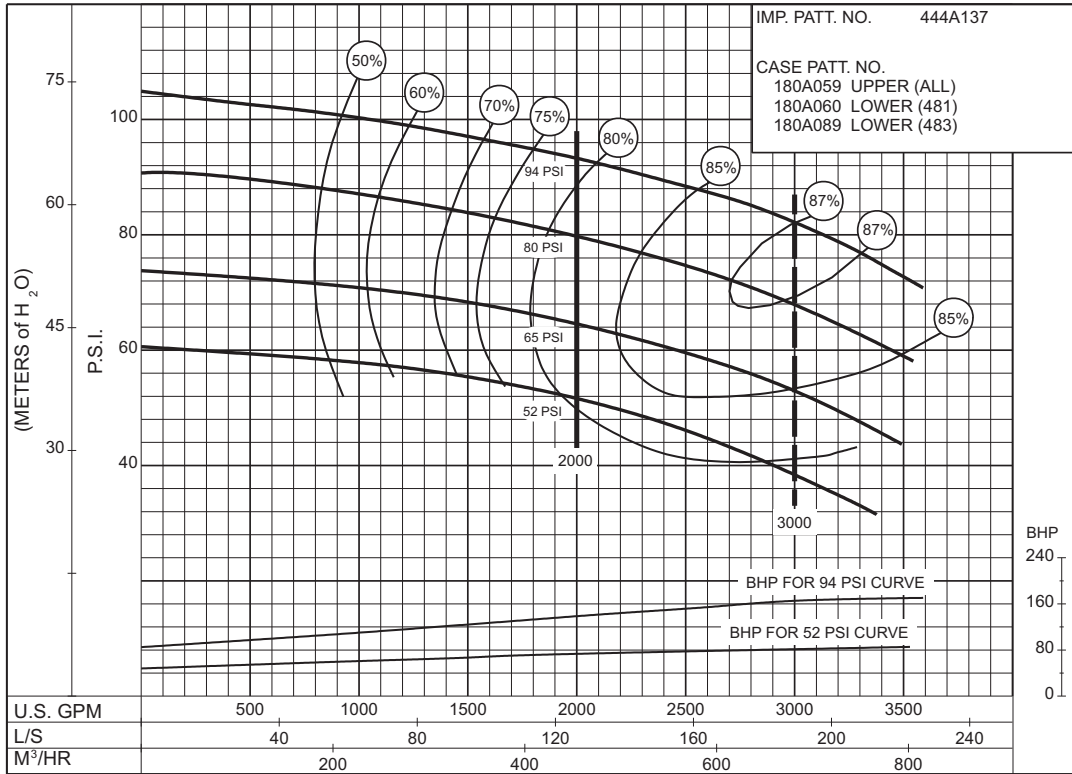

PC-147584A

**52 to 94 P.S.I.**

SIZE : 8-481-21

MODEL: 480

IMPELLER : Enclosed

R. P. M. : 1480

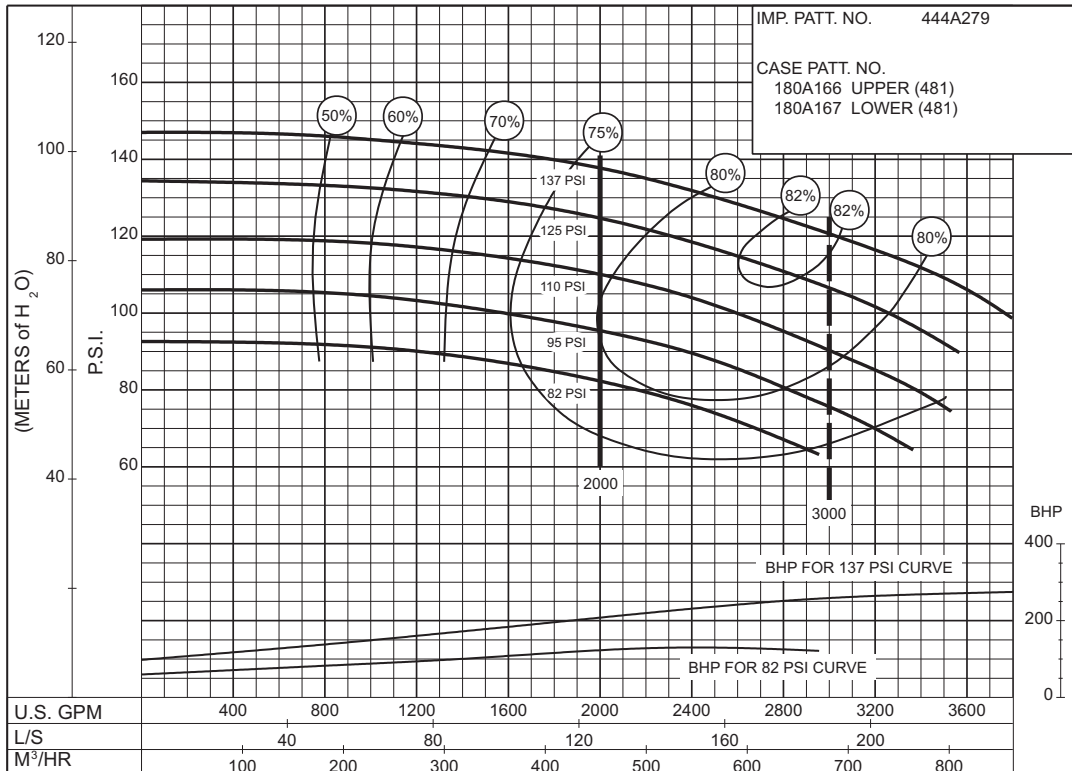

PC-147586A

**82 to 137 P.S.I.**

**2000 G.P.M. 912 SERIES**  
**50 HERTZ ELECTRIC MOTOR DRIVE**

**SIZE: 8-481-24    MODEL: 480    TYPE : ELECTRIC    IMPELLER : Enclosed    R. P. M. : 1480**

IMP. PATT. NO. 444A797  
 CASE PATT. NO. 180A509 UPPER (481)  
 180A510 LOWER (481)

**110  
to  
172  
P.S.I.**

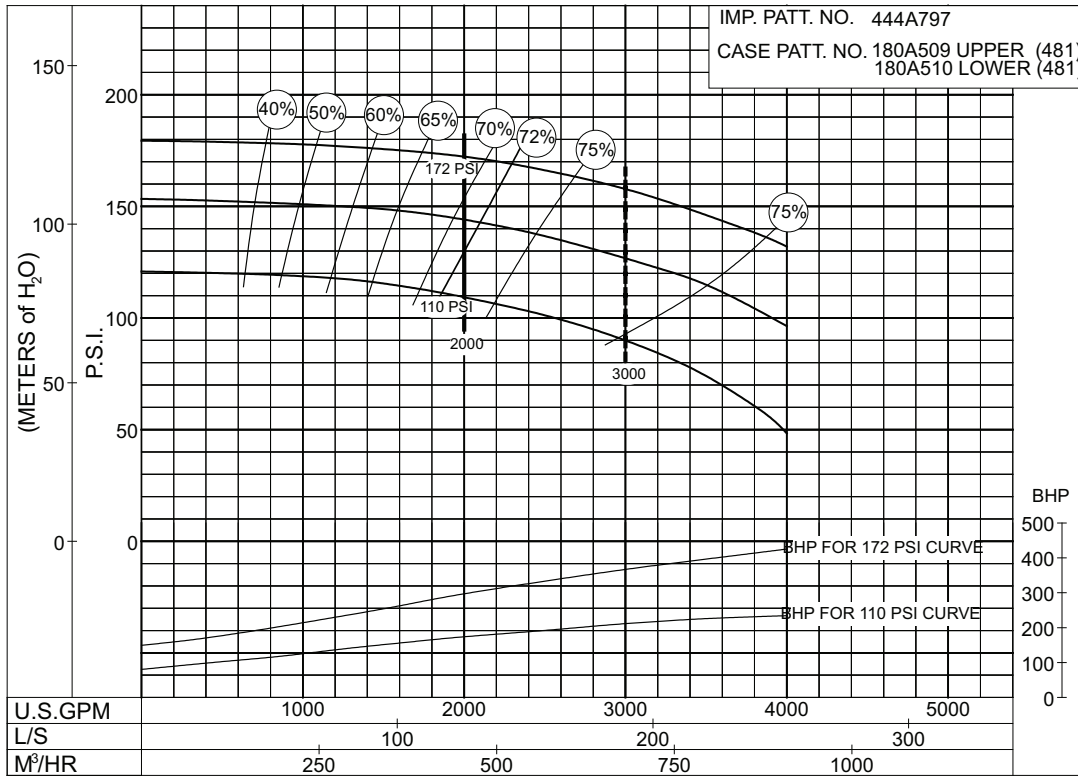

**PC- 196149**



# 2500 G.P.M. 912 SERIES

## 50 HERTZ ELECTRIC MOTOR DRIVE

SIZE : 8-481-21A

MODEL: 480

IMPELLER : Enclosed

R. P. M. : 1480

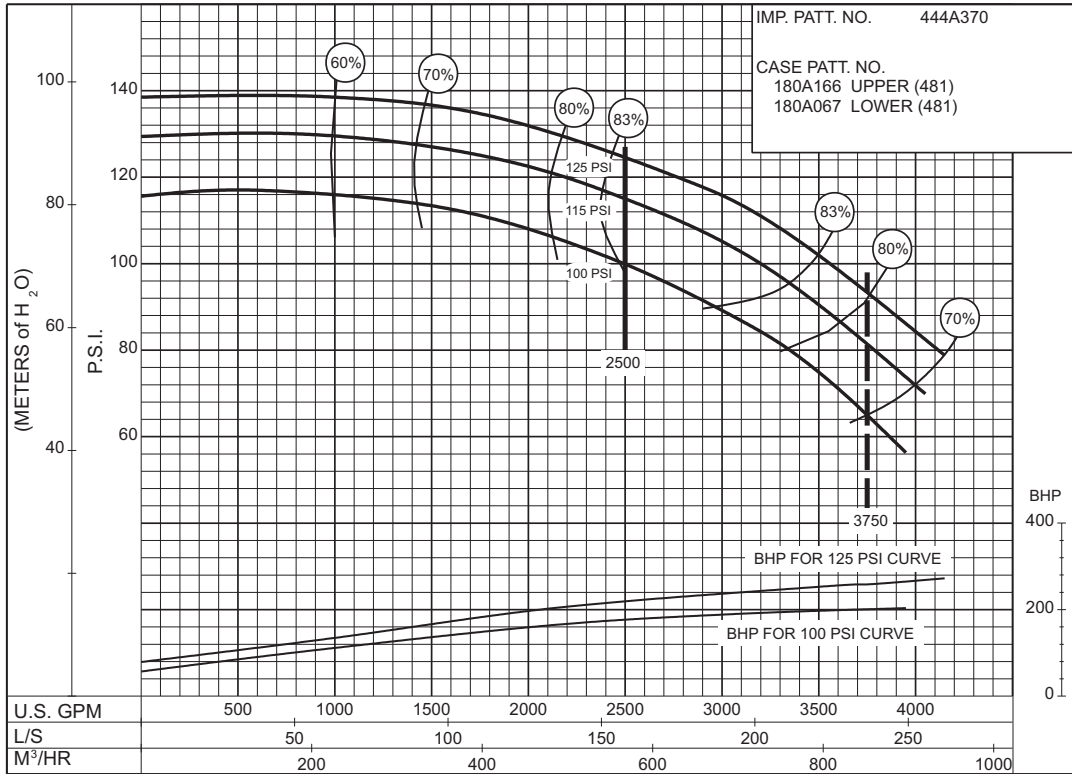

**100 to 125 P.S.I.**

SIZE: 8-481-24

MODEL: 480

TYPE : ELECTRIC

IMPELLER : Enclosed

R. P. M. : 1480

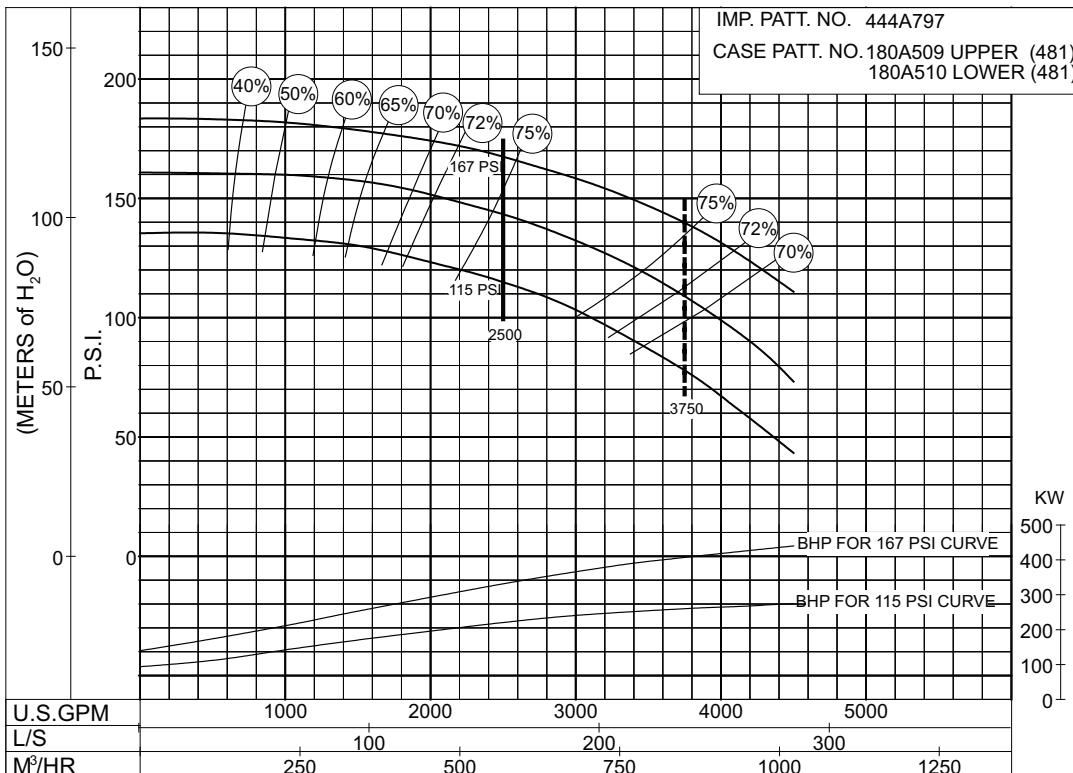

**115 to 167 P.S.I.**

**2500 G.P.M. 912 SERIES**  
**50 HERTZ ELECTRIC MOTOR DRIVE**

Supersedes Section 912 Page 617.1  
 Dated April 2000

SIZE : 10-481-18

MODEL: 480

IMPELLER : Enclosed

R. P. M. : 1480

IMP. PATT. NO. 444A146  
 CASE PATT. NO.  
 180A223 UPPER (481)  
 180A224 LOWER (481)

**65  
 to  
 101  
 P.S.I.**

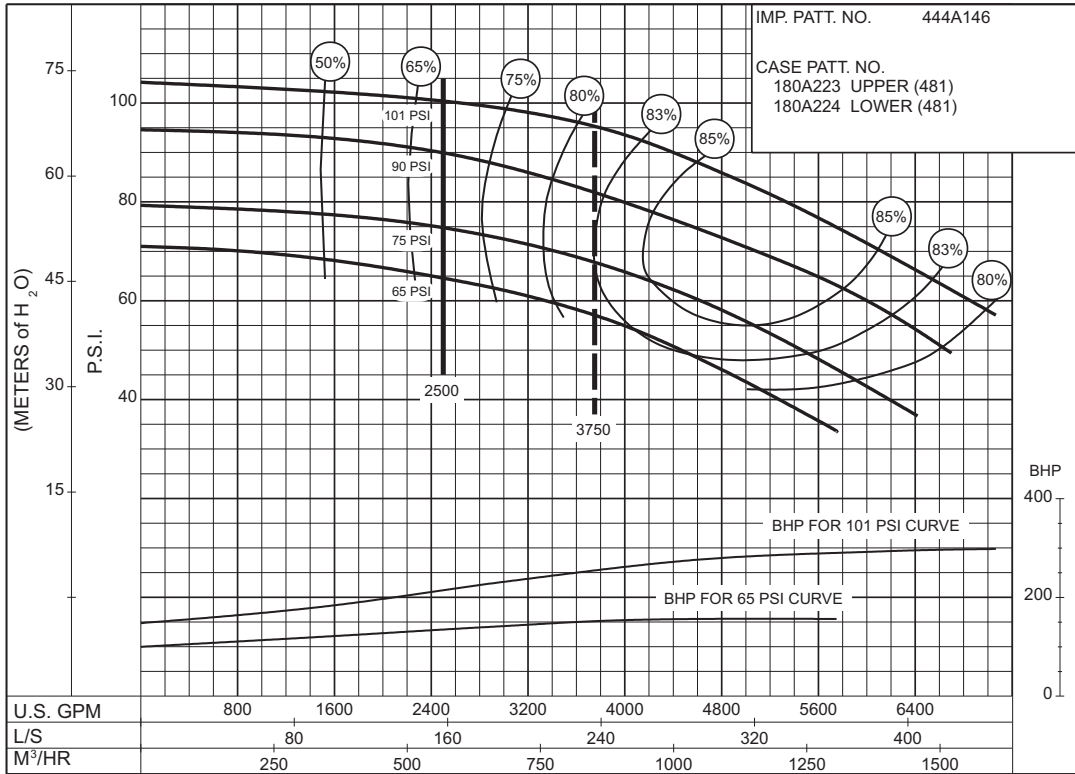

PC-147588A

THIS PAGE LEFT INTENTIONALLY BLANK

**2500 G.P.M. 912 SERIES**  
**50 HERTZ ELECTRIC MOTOR DRIVE**

**63  
to  
96  
P.S.I.**

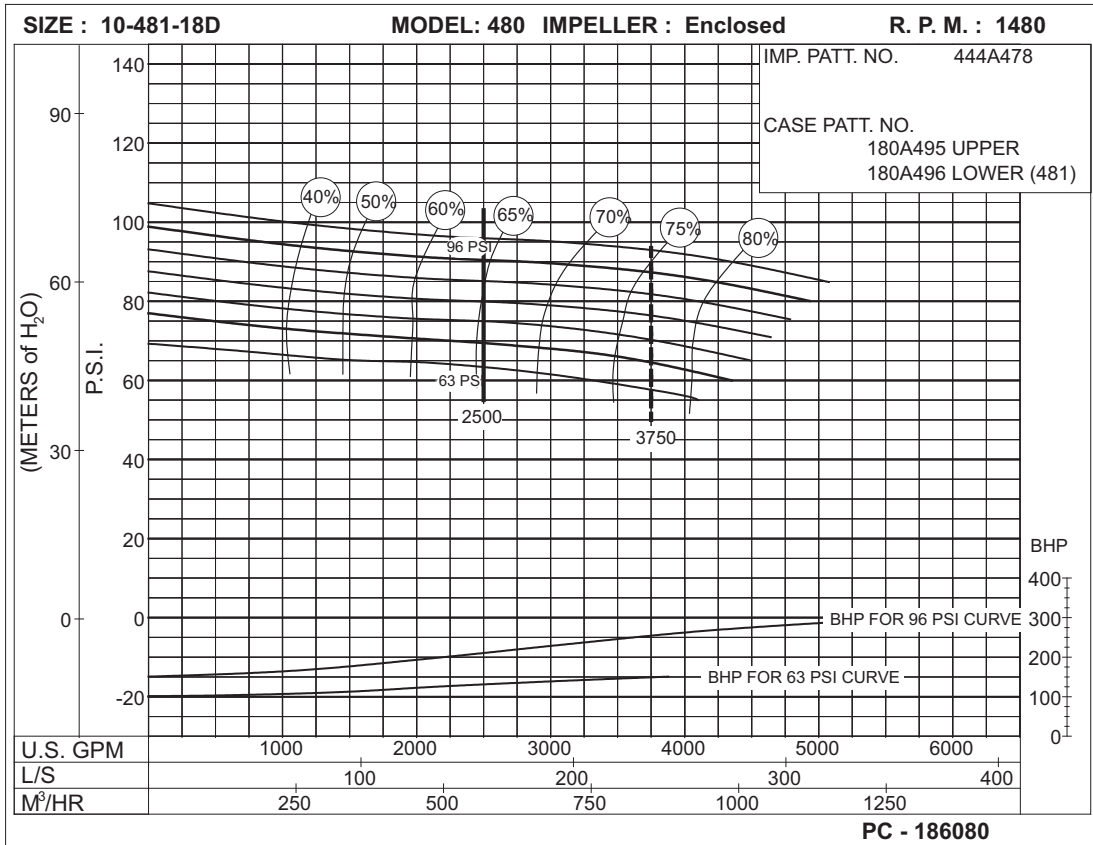

**100  
to  
171  
P.S.I.**

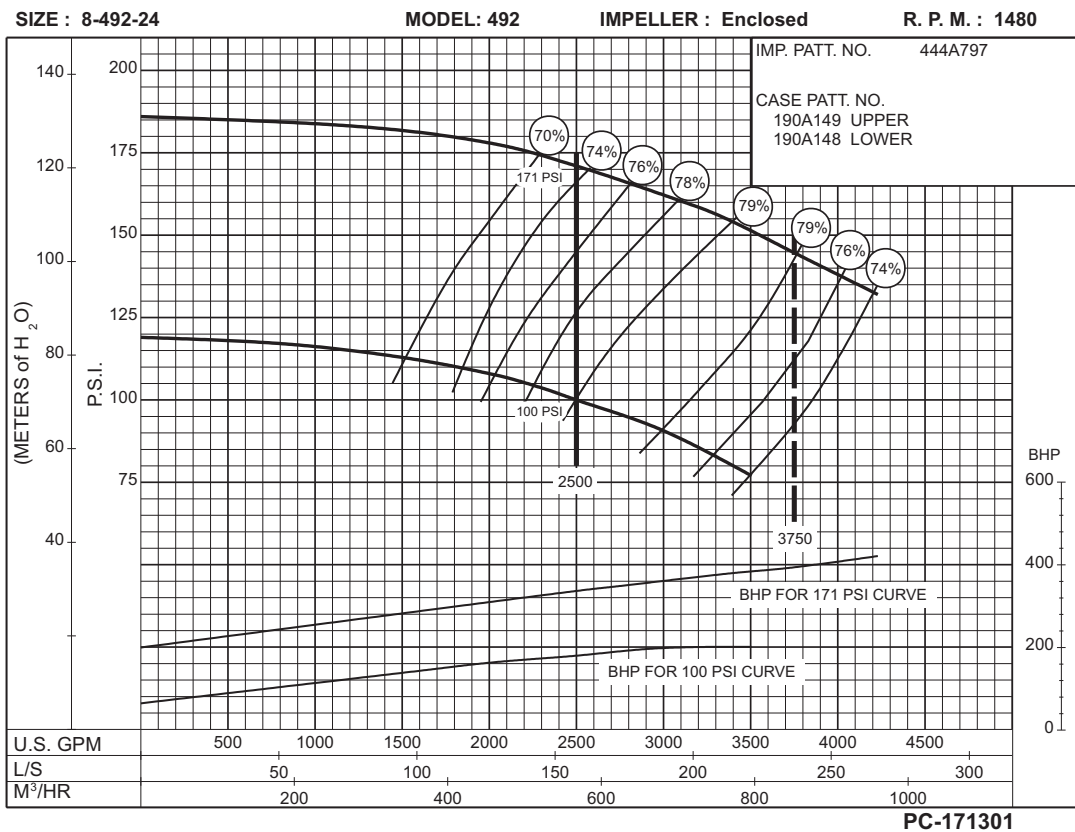

# 3000 G.P.M. 912 SERIES

## 50 HERTZ ELECTRIC MOTOR DRIVE

SIZE : 10-481-18

MODEL: 480

IMPELLER : Enclosed

R. P. M. : 1480

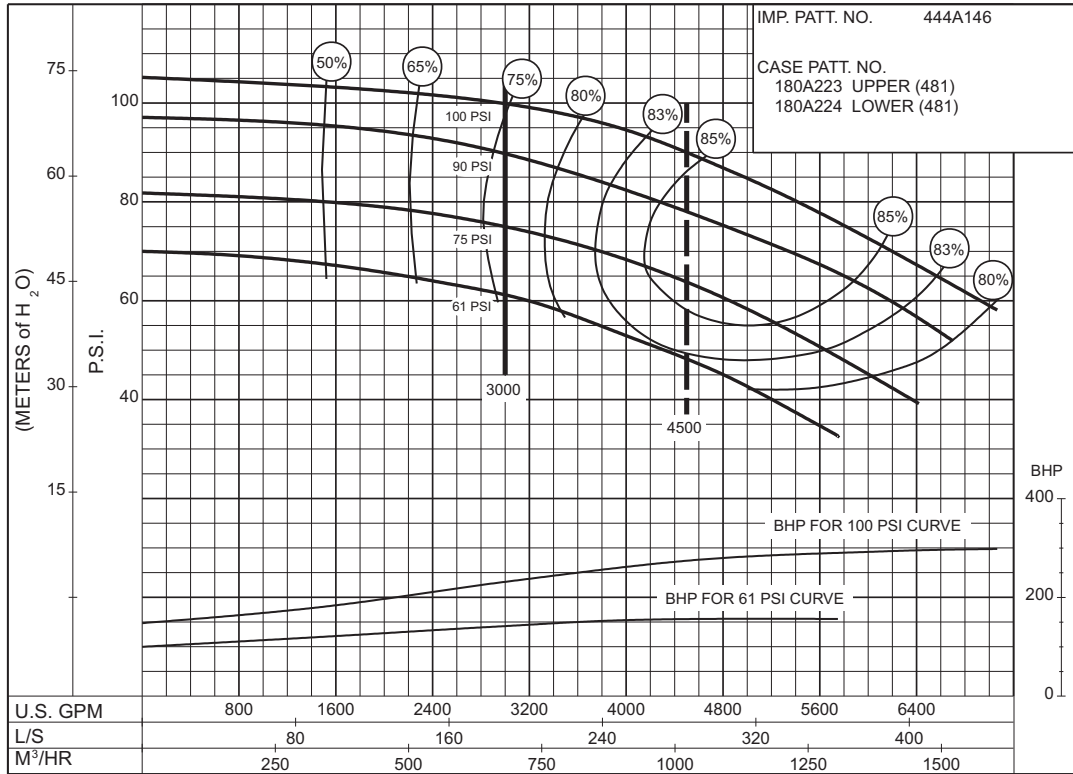

**61 to 100 P.S.I.**

SIZE : 10-481-18D

MODEL: 480 IMPELLER : Enclosed

R. P. M. : 1480

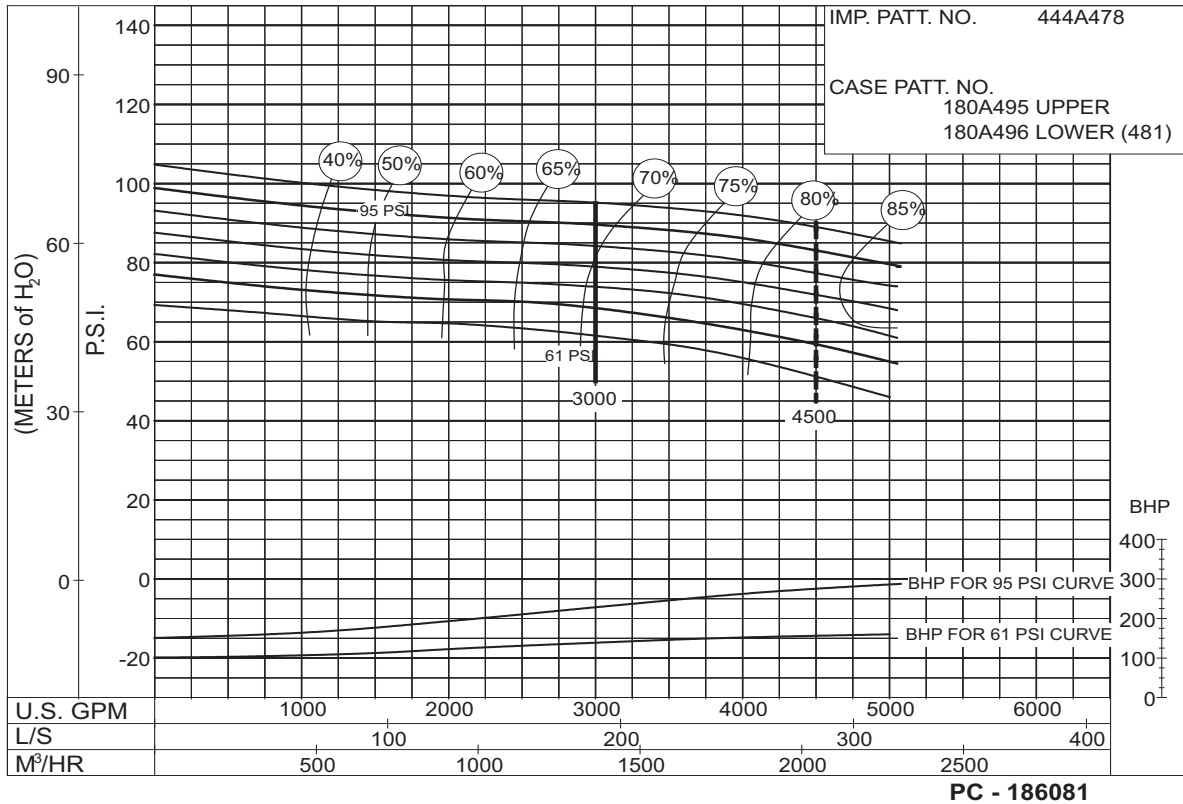

**61 to 95 P.S.I.**

Section **912** Page **620**

Date **April 2000**

Supersedes Section 912 Page 620

THIS PAGE LEFT INTENTIONALLY BLANK

# 3500 G.P.M. 912 SERIES

## 50 HERTZ ELECTRIC MOTOR DRIVE

SIZE : 10-481-18

MODEL: 480

IMPELLER : Enclosed

R. P. M. : 1480

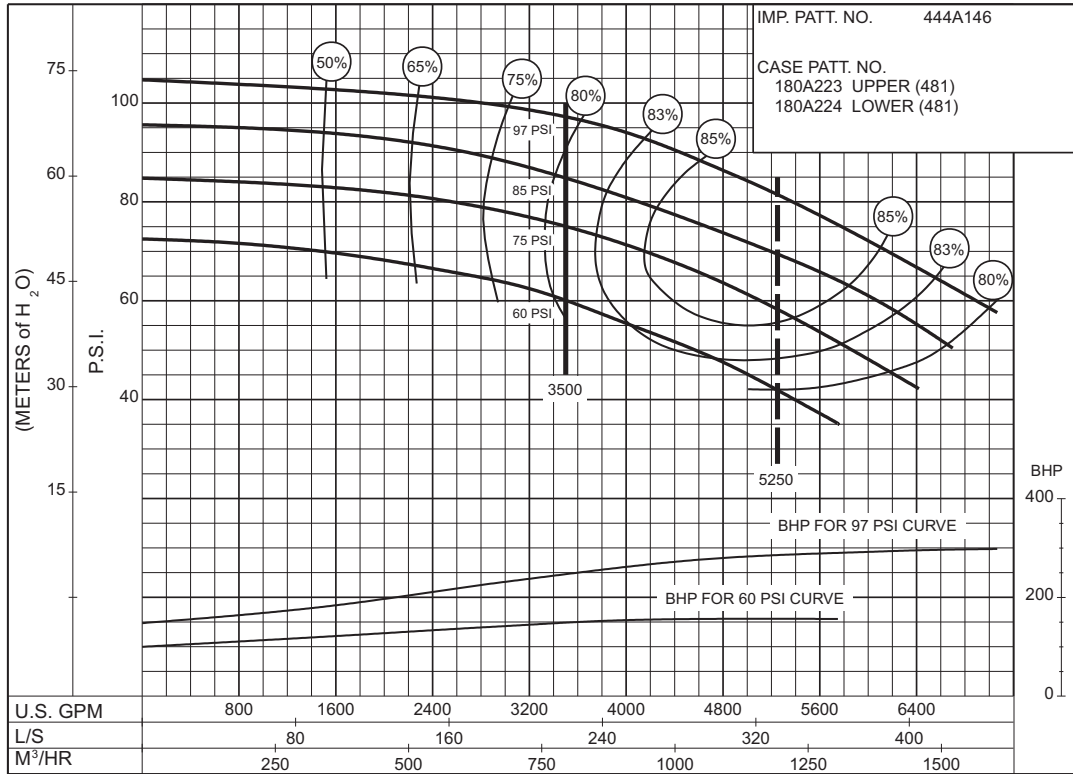

PC-147592A

**60 to 97 P.S.I.**

SIZE : 10-481-18D

MODEL: 480 IMPELLER : Enclosed

R. P. M. : 1480

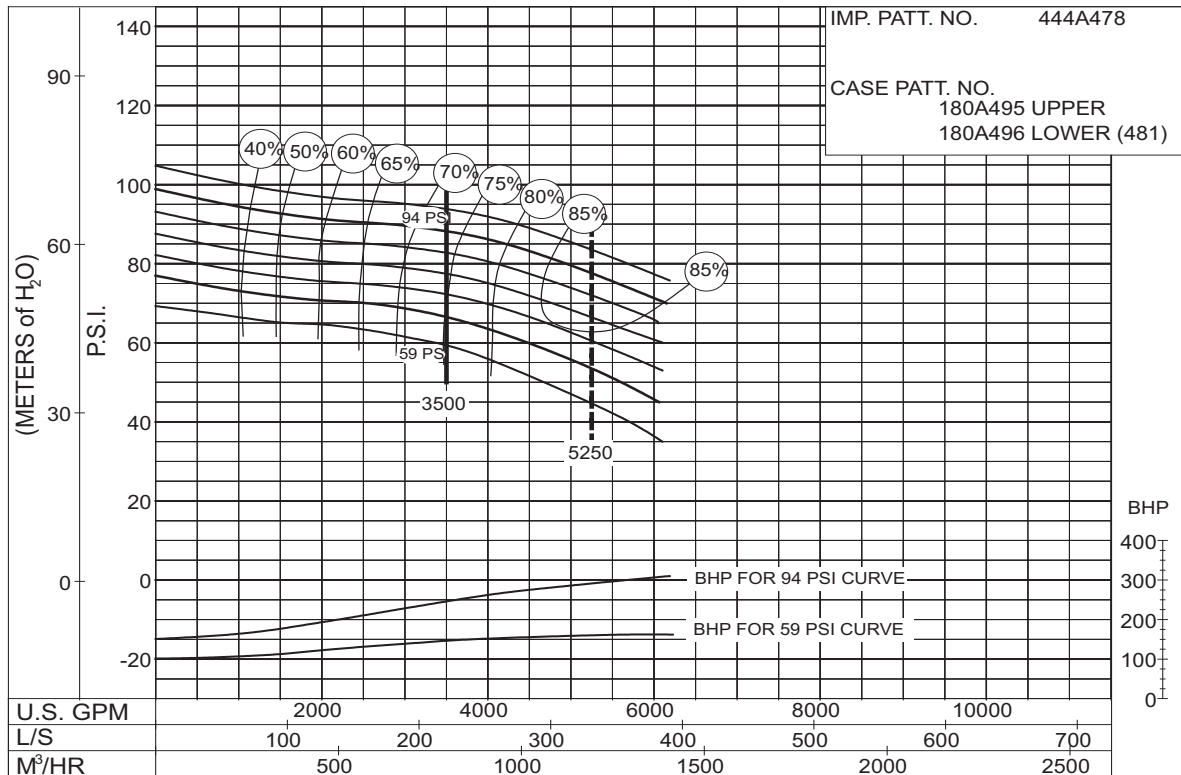

PC - 186082

**59 to 94 P.S.I.**



AURORA®

Section **912** Page **622**

Date **April 2000**

Supersedes Section 912 Page 622

THIS PAGE LEFT INTENTIONALLY BLANK



# 4000 G.P.M. 912 SERIES

## 50 HERTZ ELECTRIC MOTOR DRIVE

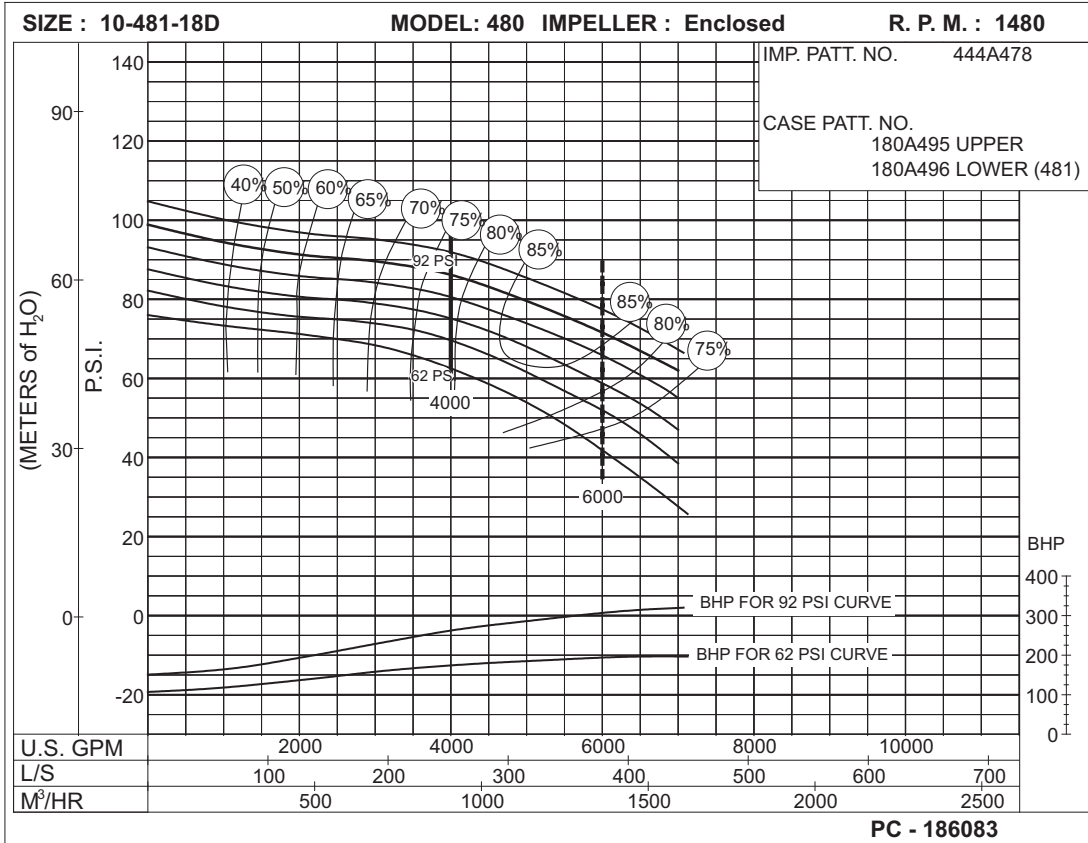

**62 to 92 P.S.I.**

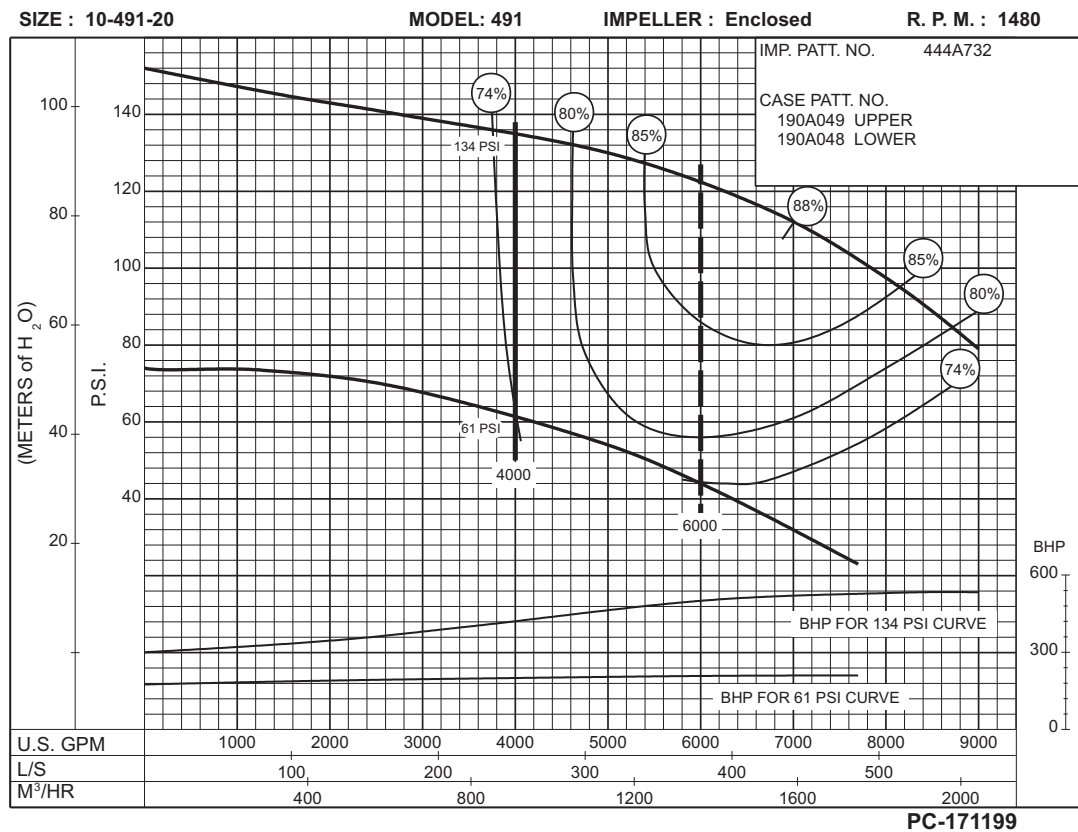

**61 to 134 P.S.I.**

# 4000 G.P.M. 912 SERIES 50 HERTZ ELECTRIC MOTOR DRIVE

SIZE : 12-481-18A

MODEL : 480

IMPELLER : Enclosed

R. P. M. : 1480

IMP. PATT. NO. 444A292

CASE PATT. NO.  
180A227 UPPER (481)  
180A228 LOWER (481)

67  
to  
103  
P.S.I.

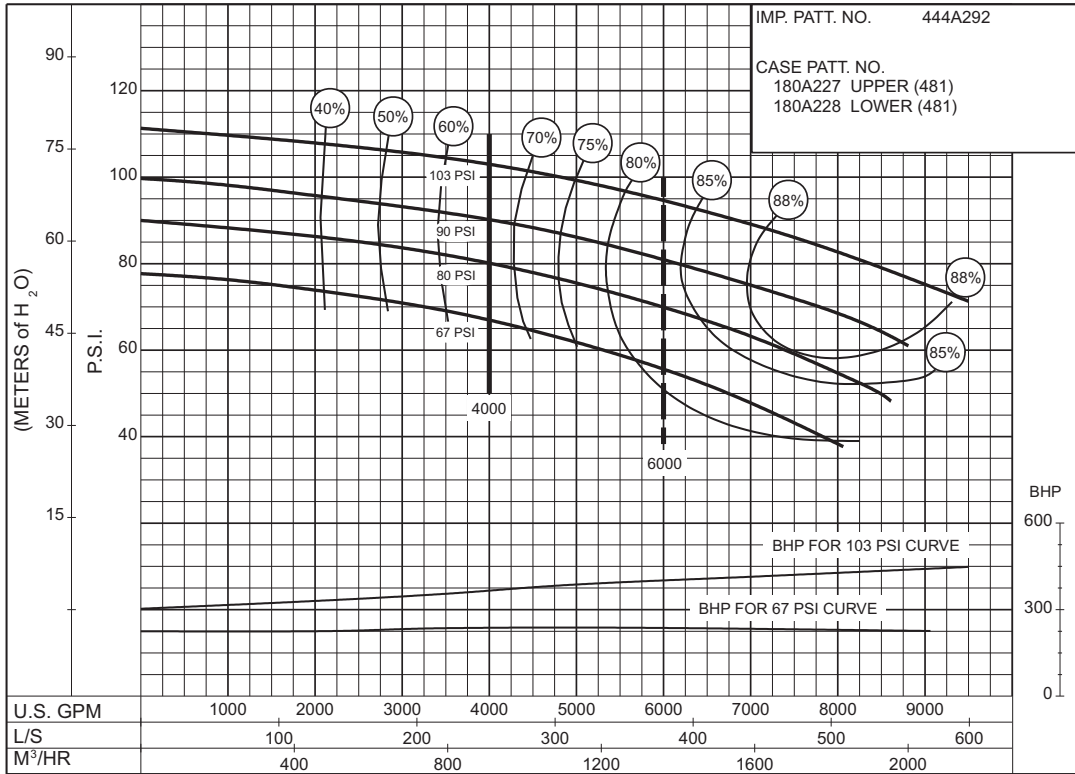

PC-147594A

# 4500 G.P.M. 912 SERIES

## 50 HERTZ ELECTRIC MOTOR DRIVE

Section **912** Page **625**

Date **April 2000**

Supersedes Section 912 Page 625

Dated August 1992

SIZE : 10-491-20

MODEL: 491

IMPELLER : Enclosed

R. P. M. : 1480

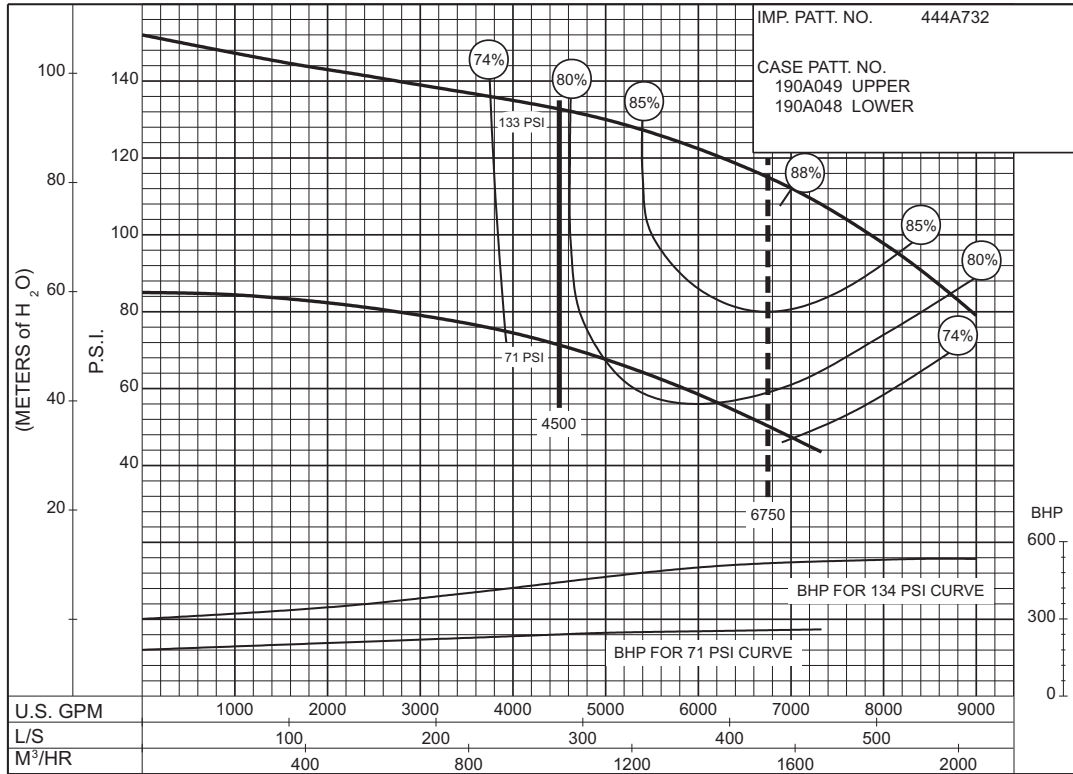

71  
to  
133  
P.S.I.

PC-171200



AURORA®

Section **912** Page **626**

Date **April 2000**

Supersedes Section 912 Page 626

THIS PAGE LEFT INTENTIONALLY BLANK

# 5000 G.P.M. 912 SERIES

## 50 HERTZ ELECTRIC MOTOR DRIVE

Section **912** Page **627**

Date **April 2000**

Supersedes Section 912 Page 627

Dated August 1992

SIZE : 10-491-20

MODEL: 491

IMPELLER : Enclosed

R. P. M. : 1480

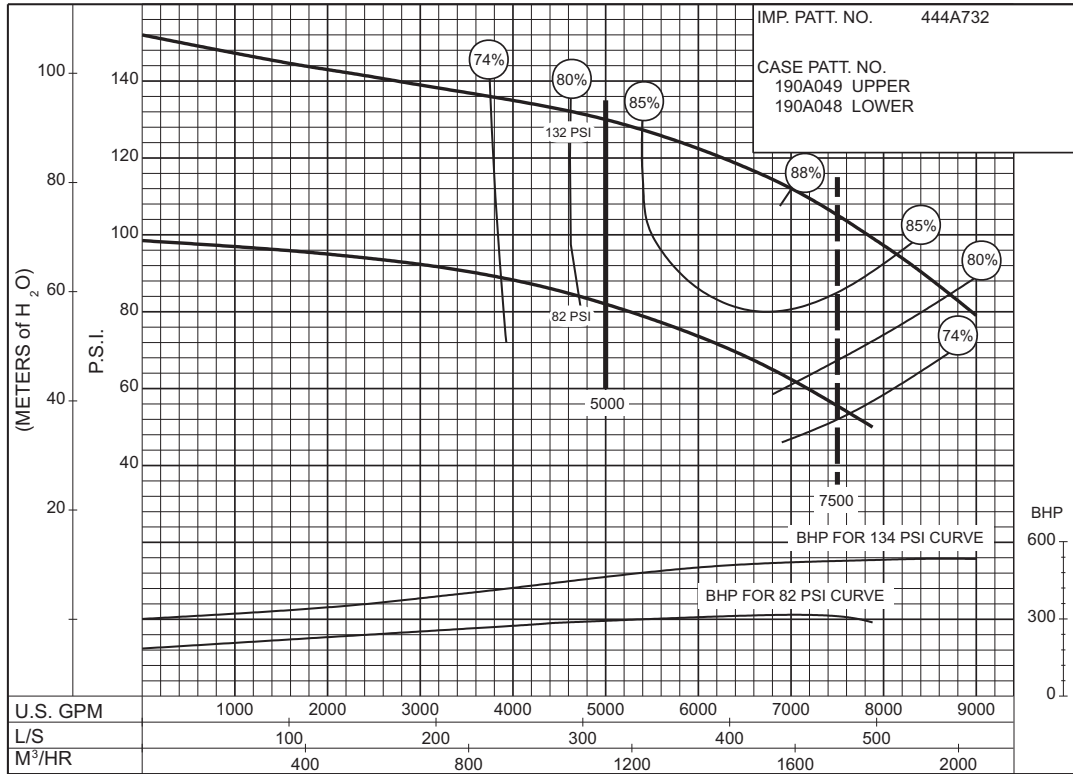

**82 to 132 P.S.I.**

PC-171201

Section **912** Page **628**

Date **April 2000**

Supersedes Section 912 Page 628

THIS PAGE LEFT INTENTIONALLY BLANK