



INTELLIFLO® VF VARIABLE FLOW PUMP



INSTALLATION AND USER'S GUIDE



IMPORTANT SAFETY INSTRUCTIONS
READ AND FOLLOW ALL INSTRUCTIONS
SAVE THESE INSTRUCTIONS



CUSTOMER SERVICE / TECHNICAL SUPPORT

If you have questions about ordering Pentair Aquatic Systems replacement parts, and pool products, please contact:

Customer Service and Technical Support, USA

(8 A.M. to 4:30 P.M. — Eastern/Pacific Times)

Phone: (800) 831-7133

Fax: (800) 284-4151

Web site

Visit www.pentairpool.com or www.staritepool.com for information about Pentair products.

Sanford, North Carolina (8 A.M. to 4:30 P.M. ET)

Phone: (919) 566-8000

Fax: (919) 566-8920

Moorpark, California (8 A.M. to 4:30 P.M. PT)

Phone: (805) 553-5000 (Ext. 5591)

Fax: (805) 553-5515

TABLE OF CONTENTS

Important Pump Warning and Safety Instructions	ii	External Control with IntelliComm	28
Introduction	1	Setting Up External Control using IntelliComm	29
Pump Overview	1	Controlling Pump with IntelliTouch	30
Pump Features	2	Connecting Pump to IntelliTouch	30
Motor Assembly	2	Backwash Mode	32
Motor Features	3	Backwash Menu	32
Drive Assembly and Control Panel	4	Running Backwash Mode	33
Operator Control Panel Features	4	Backwash Menu Screens	33
Operator Control Panel	5	Vacuum Mode	34
Control and LEDs	5	Vacuum Menu	34
Navigating the Menu Structure	7	Maintenance	35
Operating the Pump	9	Pump Strainer Basket Service	35
Metering the System	9	Motor Service	36
Manual Mode	9	Winterizing	37
Control Panel Menu	11	Manual Priming and Initial Start-up After Service	37
Menu Structure	12	Installation and Removal	38
Pool Data Mode	13	Installing the Pump	38
Priming Mode	14	Location	38
Priming Menu	14	Piping	38
Filter Mode	16	Check Valves	38
Filter Menu	16	Wiring the Pump	39
Programming Cycles Per Day	17	Pump Disassembly	40
Filter Cycle Settings	18	Pump Reassembly/Seal Replacement	41
Clean Filter Pressure Example	19	Drive Assembly Removal and Installation	42
Alert Status	19	Illustrated Parts List	43
Using Filter Mode with Features Mode	20	Replacement Parts	43
Filter Mode and Flow Control	20	Pump Dimensions	44
Flow Control and Filter Mode	20	Pump Flow and Power vs Flow Pump Curve	44
Time and Contrast Menu	21	Electrical Specifications	44
Setting System Time	21	Troubleshooting	45
Setting the LCD Backlight Contrast	21	Alerts and Warnings	45
Features Mode	22	Suction Blockage	45
Features 1-2	22	General Troubleshooting Problems	46
Features 3-9	22	General Warnings	48
M.O. Flo	22	Electrical Cost Overview	48
Features Settings	23	Making Your Pool More Energy Efficient	49
Setting Up Feature 1 or 2 (Flow and Duration)	24	Using Your Pump	49
Running Features 1 or 2 (Flow and Duration)	25	Automatic Pool Sweeps (Booster Pump Style)	49
Feature 3-9 (Flow, Start/Stop Time)	25	Filter During Off-peak Times	49
Enabling Features 3-9	25	Setting Filtering Time	49
M.O. Flo (Modulation Output Flow)	27	Preventive Maintenance	50
		Ultra Energy Efficient Pump	50

IMPORTANT PUMP WARNING AND SAFETY INSTRUCTIONS



IMPORTANT NOTICE

This guide provides installation and operation instructions for this pump. Consult Pentair with any questions regarding this equipment.

Attention Installer: This guide contains important information about the installation, operation and safe use of this product. This information should be given to the owner and/or operator of this equipment after installation or left on or near the pump.

Attention User: This manual contains important information that will help you in operating and maintaining this product. Please retain it for future reference.

READ AND FOLLOW ALL INSTRUCTIONS SAVE THESE INSTRUCTIONS



This is the safety alert symbol. When you see this symbol on your system or in this manual, look for one of the following signal words and be alert to the potential for personal injury.

DANGER

Warns about hazards that can cause death, serious personal injury, or major property damage if ignored.

WARNING

Warns about hazards that may cause death, serious personal injury, or major property damage if ignored.

CAUTION

Warns about hazards that may or can cause minor personal injury or property damage if ignored.

NOTE

Indicates special instructions not related to hazards.

Carefully read and follow all safety instructions in this manual and on equipment. Keep safety labels in good condition; replace if missing or damaged.

When installing and using this electrical equipment, basic safety precautions should always be followed, include the following:

WARNING

Do not permit children to use this product.

WARNING

RISK OF ELECTRICAL SHOCK. Connect only to a branch circuit protected by a ground-fault circuit-interrupter (GFCI). Contact a qualified electrician if you cannot verify that the circuit is protected by a GFCI.

WARNING

This unit must be connected only to a supply circuit that is protected by a ground-fault circuit-interrupter (GFCI). Such a GFCI should be provided by the installer and should be tested on a routine basis. To test the GFCI, push the test button. The GFCI should interrupt power. Push the reset button. Power should be restored. If the GFCI fails to operate in this manner, the GFCI is defective. If the GFCI interrupts power to the pump without the test button being pushed, a ground current is flowing, indicating the possibility of an electric shock. Do not use this pump. Disconnect the pump and have the problem corrected by a qualified service representative before using.

CAUTION

This pump is for use with permanent swimming pools and may also be used with hot tubs and spas if so marked. Do not use with storable pools. A permanently-installed pool is constructed in or on the ground or in a building such that it cannot be readily disassembled for storage. A storable pool is constructed so that it is capable of being readily disassembled for storage and reassembled to its original integrity.

General Warnings

- Never open the inside of the drive motor enclosure. There is a capacitor bank that holds a 230 VAC charge even when there is no power to the unit.
- The pump is not submersible.
- The pump is capable of high flow rates; use caution when installing and programming to limit pumps performance potential with old or questionable equipment.
- Code requirements for electrical connection differ from country to country, state to state, as well as local municipalities. Install equipment in accordance with the National Electrical Code and all applicable local codes and ordinances.
- Before servicing the pump; switch OFF power to the pump by disconnecting the main circuit to the pump.
- This appliance is not intended for use by persons (including children) of reduced physical, sensory or mental capabilities, or lack of experience and knowledge, unless they have been given supervision or instruction concerning the use of the appliance by a person responsible for their safety.

DANGER

FAILURE TO FOLLOW ALL INSTRUCTIONS AND WARNINGS CAN RESULT IN SERIOUS BODILY INJURY OR DEATH. **THIS PUMP SHOULD BE INSTALLED AND SERVICED ONLY BY A QUALIFIED POOL SERVICE PROFESSIONAL. INSTALLERS, POOL OPERATORS AND OWNERS MUST READ THESE WARNINGS AND ALL INSTRUCTIONS IN THE OWNER'S MANUAL BEFORE USING THIS PUMP. THESE WARNINGS AND THE OWNER'S MANUAL MUST BE LEFT WITH THE POOL OWNER.**

DANGER

SUCTION ENTRAPMENT HAZARD: STAY OFF THE MAIN DRAIN AND AWAY FROM ALL SUCTION OUTLETS!



THIS PUMP PRODUCES HIGH LEVELS OF SUCTION AND CREATES A STRONG VACUUM AT THE MAIN DRAIN AT THE BOTTOM OF THE BODY OF WATER. THIS SUCTION IS SO STRONG THAT IT CAN TRAP ADULTS OR CHILDREN UNDER WATER IF THEY COME IN CLOSE PROXIMITY TO A DRAIN OR A LOOSE OR BROKEN DRAIN COVER OR GRATE.

THE USE OF UNAPPROVED COVERS OR ALLOWING USE OF THE POOL OR SPA WHEN COVERS ARE MISSING, CRACKED OR BROKEN CAN RESULT IN BODY OR LIMB ENTRAPMENT, HAIR ENTANGLEMENT, BODY ENTRAPMENT, EVISCERATION AND/OR DEATH.

The suction at a drain or outlet can cause:

Limb Entrapment: When a limb is sucked or inserted into an opening resulting in a mechanical bind or swelling. This hazard is present when a drain cover is missing, broken, loose, cracked or not properly secured.

Hair Entanglement: When the hair tangles or knots in the drain cover, trapping the swimmer underwater. This hazard is present when the flow rating of the cover is too small for the pump or pumps.

Body Entrapment: When a portion of the body is held against the drain cover trapping the swimmer underwater. This hazard is present when the drain cover is missing, broken or the cover flow rating is not high enough for the pump or pumps.

Evisceration/Disembowelment: When a person sits on an open pool (particularly a child wading pool) or spa outlet and suction is applied directly to the intestines, causing severe intestinal damage. This hazard is present when the drain cover is missing, loose, cracked, or not properly secured.

IMPORTANT PUMP WARNING AND SAFETY INSTRUCTIONS

Mechanical Entrapment: When jewelry, swimsuit, hair decorations, finger, toe or knuckle is caught in an opening of an outlet or drain cover. This hazard is present when the drain cover is missing, broken, loose, cracked, or not properly secured.

NOTE: ALL SUCTION PLUMBING MUST BE INSTALLED IN ACCORDANCE WITH THE LATEST NATIONAL AND LOCAL CODES, STANDARDS AND GUIDELINES.

WARNING

TO MINIMIZE THE RISK OF INJURY DUE TO SUCTION ENTRAPMENT HAZARD:

- A properly installed and secured ANSI/ASME A112.19.8 approved anti-entrapment suction cover must be used for each drain.
- Each suction cover must be installed at least three (3') feet apart, as measured from the nearest point to nearest point.
- Regularly inspect all covers for cracks, damage and advanced weathering.
- If a cover becomes loose, cracked, damaged, broken or is missing, replace with an appropriate certified cover.
- Replace drain covers as necessary. Drain covers deteriorate over time due to exposure to sunlight and weather.
- Avoid getting hair, limbs or body in close proximity to any suction cover, pool drain or outlet.
- Disable suction outlets or reconfigure into return inlets.

WARNING

A clearly labeled emergency shut-off switch for the pump must be in an easily accessible, obvious place.

Make sure users know where it is and how to use it in case of emergency.

The Virginia Graeme Baker (VGB) Pool and Spa Safety Act creates new requirements for owners and operators of commercial swimming pools and spas.

Commercial pools or spas constructed on or after December 19, 2008, shall utilize:

(A) A multiple main drain system without isolation capability with suction outlet covers that meet ASME/ANSI A112.19.8a Suction Fittings for Use in Swimming Pools, Wading Pools, Spas, and Hot Tubs and either:

- (i) A safety vacuum release system (SVRS) meeting ASME/ANSI A112.19.17 Manufactured Safety Vacuum Release systems (SVRS) for Residential and Commercial Swimming Pool, Spa, Hot Tub, and Wading Pool Suction Systems and/or ASTM F2387 Standard Specification for Manufactured Safety Vacuum Release Systems (SVRS) for Swimming pools, Spas and Hot Tubs or
- (ii) A properly designed and tested suction-limiting vent system or
- (iii) An automatic pump shut-off system.

Commercial pools and spas constructed prior to December 19, 2008, with a single submerged suction outlet shall use a suction outlet cover that meets ASME/ANSI A112.19.8a and either:

- (A) A SVRS meeting ASME/ANSI A112.19.17 and/or ASTM F2387, or
- (B) A properly designed and tested suction-limiting vent system, or
- (C) An automatic pump shut-off system, or
- (D) Disabled submerged outlets, or
- (E) Suction outlets shall be reconfigured into return inlets.

For Installation of Electrical Controls at Equipment Pad (ON/OFF Switches, Timers and Automation Load Center)

CAUTION

Install all electrical controls at equipment pad, such as on/off switches, timers, and control systems, etc. to allow the operation (startup, shut-down, or servicing) of any pump or filter so the user does not place any portion of his/her body over or near the pump strainer lid, filter lid or valve closures. This installation should allow the user enough space to stand clear of the filter and pump during system start-up, shut down or servicing of the system filter.



DANGER

HAZARDOUS PRESSURE: STAND CLEAR OF PUMP AND FILTER DURING START UP



Circulation systems operate under high pressure. When any part of the circulating system (i.e. locking ring, pump, filter, valves, etc.) is serviced, air can enter the system and become pressurized.

Pressurized air can cause the pump housing cover, filter lid, and valves to violently separate which can result in severe personal injury or death. Filter tank lid and strainer cover must be properly secured to prevent violent separation. Stand clear of all circulation system equipment when turning on or starting up pump.

Before servicing equipment, make note of the filter pressure. Be sure that all controls are set to ensure the system cannot inadvertently start during service. Turn off all power to the pump. **IMPORTANT: Place filter manual air relief valve in the open position and wait for all pressure in the system to be relieved.**

Before starting the system, fully open the manual air relief valve and place all system valves in the "open" position to allow water to flow freely from the tank and back to the tank. Stand clear of all equipment and start the pump.

IMPORTANT: Do not close filter manual air relief valve until all pressure has been discharged from the valve and a steady stream of water appears. Observe filter pressure gauge and be sure it is not higher than the pre-service condition.

General Installation Information

- All work must be performed by a qualified service professional, and must conform to all national, state, and local codes.
- Install to provide drainage of compartment for electrical components.
- These instructions contain information for a variety of pump models and therefore some instructions may not apply to a specific model. All models are intended for use in swimming pool applications. The pump will function correctly only if it is properly sized to the specific application and properly installed.

WARNING

Pumps improperly sized or installed or used in applications other than for which the pump was intended can result in severe personal injury or death. These risks may include but not be limited to electric shock, fire, flooding, suction entrapment or severe injury or property damage caused by a structural failure of the pump or other system component.

WARNING

The pump can produce high levels of suction within the suction side of the plumbing system. These high levels of suction can pose a risk if a person comes within the close proximity of the suction openings. A person can be seriously injured by this high level of vacuum or may become trapped and drown. It is absolutely critical that the suction plumbing be installed in accordance with the latest national and local codes for swimming pools.

Warnings and safety instructions for Pentair Aquatic Systems pumps and other related products are available at:

<http://www.pentairpool.com/pool-owner/safety-warnings/> or call (800) 831-7133 for additional free copies of these instructions.

Please refer to <http://www.pentairpool.com/pool-owner/safety-warnings/> for warning and safety instructions related to the this product.

SAVE THESE INSTRUCTIONS

INTRODUCTION

Pump Overview

The IntelliFlo® VF Variable Flow Pump control system offers pool and spa filter automation and advanced features that include energy conservation and programmable scheduled water features for your pool, spa, cleaner, waterfall, and other applications.

The pump can adapt to any application up to 130 gallons per minute, you simply program the pump to suit the application. The pump then dials in the perfect operating conditions for that specific flow rate.

The pump can reduce energy cost by as much as 90% based on a pool size up to 15,000 gallons, one turn per day with a 24 hour cycle.

The pump constantly monitors water flow and electrical current to ensure that the filtration system is operating at peak efficiency. This can result in maximum energy efficiency savings never before possible – up to 90% over conventional single speed and two speed pumps. The system protects against loss of prime or impedance of flow, under and over voltage situations, and thermal overload or freezing.

There is no need for pump curves and hydraulic calculations to determine the right pump for the job. Just set the program for your pool size and desired turnover, and the pump does the rest.

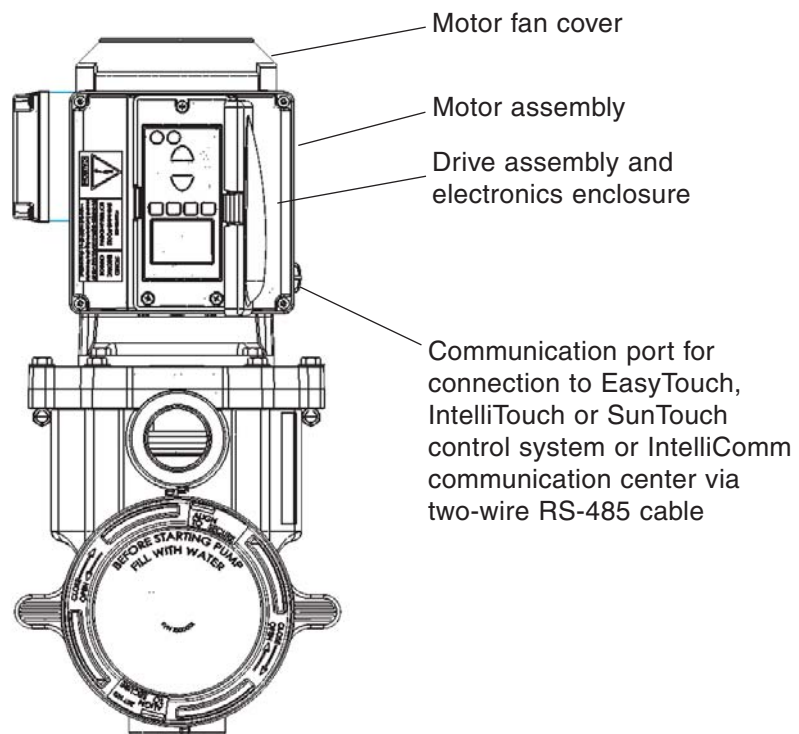

IntelliFlo VF (variable flow pump)

Pump Features

- Sizes itself to any pool
- Reduces energy cost by as much as 90%
- Protects against loss of prime or flow blockage
- Prevents thermal overload
- Detects and prevents damage from under and over voltage conditions
- Protects against freezing
- Can communicate with an IntelliTouch® Control System or IntelliComm® Communication Center via a two-wire connection
- Easy to read operator control panel LCD display
- Operator control panel buttons for pump modes
- Built-in strainer pot and volute
- Ultra energy-efficient TEFC Square Flange Motor
- Compatibility with most cleaning systems, filters, and jet action spas
- 16-button LCD control panel
- Drive assembly features permanent magnet synchronous motor
- Heavy-duty, durable construction designed for long life
- Internal 24-hour clock for setting controlled on/off times for filtering and up to ten water features
- UL Listed

Motor Assembly

The IntelliFlo® VF Variable Flow Pump's three-phase, six-pole, permanent magnet motor operates at 90% efficiency. The motor assembly is continually cooled by an external fan. Dual seals on the motor shaft and at the fan assembly seal the entire motor from any moisture entering the motor assembly. For added protection, a slinger located in front of the main shaft seal assists in slinging water away from the shaft opening in the flange.

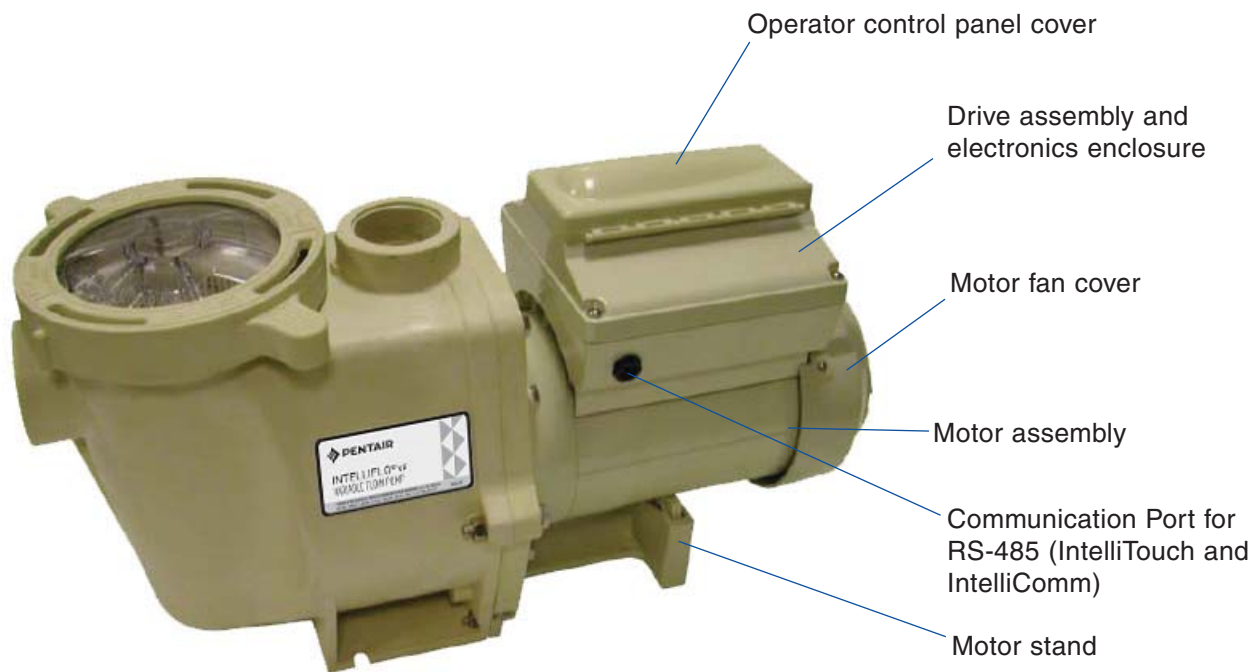

IntelliFlo VF Motor Assembly

Motor Features

- Permanent Magnet Synchronous Motor (PMSM)
- High efficiency (3450 RPM 92% and 400 RPM 90%)
- Superior speed control
- Operates at lower temperatures due to high efficiency
- Same technology as deployed in hybrid electric vehicles
- Designed to withstand outdoor environment
- Totally Enclosed Fan Cooled
- Three-phase motor
- 56 Square Flange
- Six-Pole
- Low noise

Drive Assembly and Control Panel

The IntelliFlo® VF Variable Flow Pump drive assembly consists of an operator control panel and the system electronics that drive the 230 VAC single phase (260 VAC~170 VAC) motor. The drive microprocessor controls the motor by changing the frequency of the current it receives together with changing the voltage to control the rotational speed.

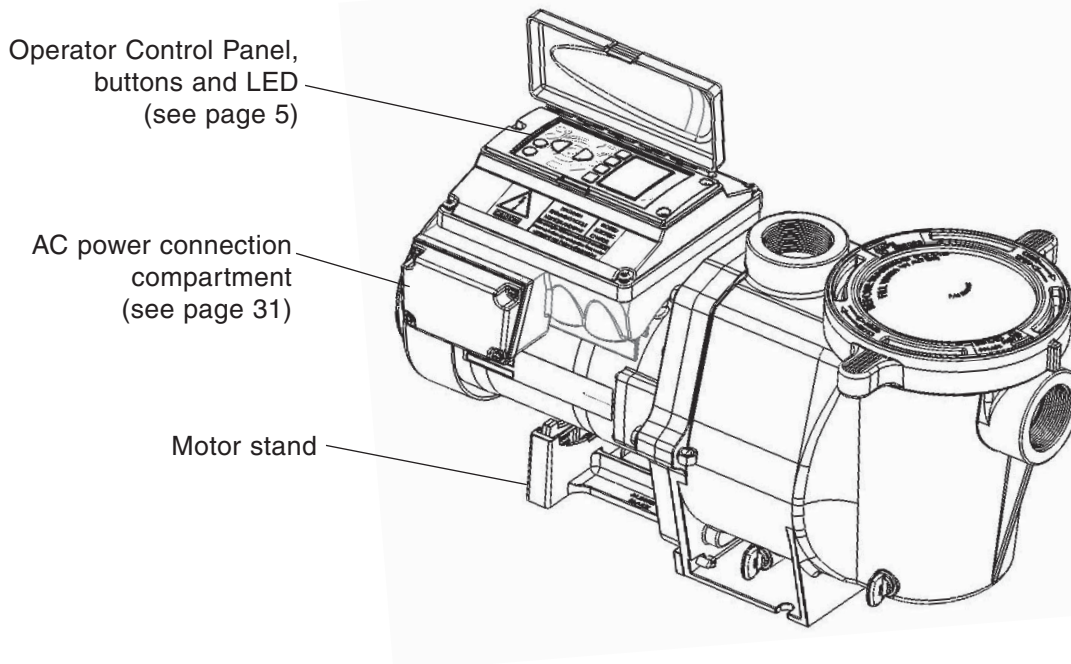

IntelliFlo Drive Assembly

Operator Control Panel Features

- **Backwash and Rinse** — Informs the user when and how to backwash filter media
- **Vacuum** — Can be preset using duration and flow parameters to save energy
- **Filter** — Allows pump to run at peak efficiency, saving users up to 90% in energy cost, based on a pool size up to 15,000 gallons, one turn per day with a 24 hour cycle.
- **Feature** — Ten feature modes can be programmed to control filtration duration, start and stop time, and frequency for cleaners, water features, spas, and waterfalls
- **Manual** — Allows the user to override all programming and run the pump using RPM or flow (GPM) control parameters. All personnel safety devices and alarms do not operate in speed mode.

OPERATOR CONTROL PANEL

This section describes the operator control panel controls and LEDs.

IntelliFlo® VF Operator Control Panel

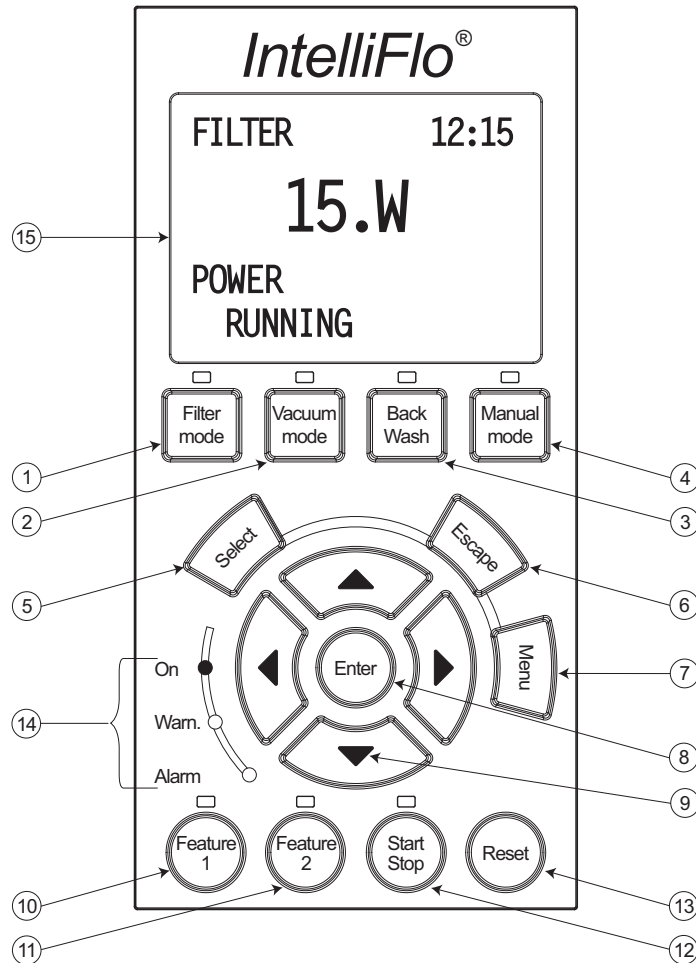

Controls and LEDs

- ① **Filter button/LED:** Starts Filter mode. The LED is on when Filter mode is active.
- ② **Vacuum button/LED:** Starts Vacuum mode. The LED is on when Vacuum mode is active.
- ③ **Backwash button/LED:** Starts Backwash mode. The LED is on when Backwash mode is active.
- ④ **Manual button/LED:** Starts Manual mode. The LED is on when Manual mode is active.
- ⑤ **Select button:** Display available menu items or enters edit mode for changing a value on line two of the display.
- ⑥ **Escape button:** Go to the next level up in the menu structure or stop editing the current setting.
- ⑦ **Menu button:** Access the menu items if the pump is stopped.
- ⑧ **Enter button:** Save current menu item setting. Also, press this button to acknowledge alarms and warning alerts.

Controls and LEDs (Continued)

⑨ Arrow buttons:

- **Up arrow:** Move one level up in the menu tree or increase a digit when editing a setting.
- **Down arrow:** Move one level down in the menu tree or decrease a digit when editing a setting.
- **Left arrow:** Move cursor left one digit when editing a setting.
- **Right arrow:** Move cursor right one digit when editing a setting.

⑩ **Feature 1 button:** Starts Feature 1 mode. The LED is lit when mode is active.

⑪ **Feature 2 button:** Starts Feature 2 mode. The LED is lit when mode is active.

⑫ **Start/Stop button:** Start or Stop the IntelliFlo® VF Variable Flow Pump. When the LED is lit it indicates that the pump is currently running or in a mode to start automatically.

⑬ **Reset button:** Reset alarm or alert.

LEDs

- ⑭ {
- On:** This green LED is on when pump is powered on.
 - Warning:** This LED is on if a warning condition is present.
 - Alarm:** This LED is on if an alarm condition has occurred.

⑮ Control Panel LCD Display











LCD Display Lines:

- **Line 1** - Mode and time. To set A.M. and P.M. time, refer to “Time and Contrast Menu” on page 21.
- **Line 2** - Data
- **Line 3** - Name of data in line 2
- **Line 4** - Run status













Navigating the Menu Structure

Before navigating the control panel menu structure, first familiarize yourself with the menu buttons. To change a parameter setting, use the **Left** and **Right** arrow buttons to select the digit, then the **Up** and **Down** arrow buttons to edit the digit. The following example shows how to set the GPM and priming time in the “Priming” menu (see page 14).

To set the “Priming” mode settings:

1. Ensure that the green power LED is on and the IntelliFlo® VF Variable Flow Pump is stopped. If the pump is running, press the  **Start/Stop** button.
2. Press the  **Menu** button. “Pool Data” is displayed.
3. Press the  **Down** arrow to select “Priming”.
4. Press the  **Select** button to access “Max Priming Flow” setting.
5. **Set the GPM:** Press the  **Select** button to set the gallons per minute (GPM) value.
6. To change the GPM value, press the  **Left** and **Right** arrows to select which digit to modify.
Press the  **Up** and **Down** arrows to change the selected digit. For setting values, see “Priming menu options” below.
7. When you are done, press the  **Enter** button to save the changes.
To cancel any changes, press the  **Escape** button to exit edit mode without saving.
8. **Set the priming time:** Use the  **Up** and **Down** arrows to select “Max Priming Time” and “System Priming Time.”
Press the  **Select** to edit the setting.
9. Repeat steps 5, 6, and 7 to edit the setting.

Priming Mode Example

	MENU 12:15 Pool Data
	MENU 12:15 Priming
	Priming 12:15 55. GPM Max Priming Flow
	Priming 12:15 0055. GPM Max Priming Flow
	Priming 12:15 0055. GPM Max Priming Flow
	Priming 12:15 0065. GPM Max Priming Flow
	Priming 12:15 0065. GPM Max Priming Flow
	Priming 12:15 0060. GPM Max Priming Flow
5X	
	Priming 12:15 60. GPM Max Priming Flow
	Priming 12:15 15. MIN Max Priming Time
	Priming 12:15 0. MIN System Priming Time
	MENU 12:15 Priming

[Blank Page]

OPERATING THE PUMP

This section describes how to use the IntelliFlo® VF Variable Flow Pump control panel.

Metering the System

The first step to operating and programming the pump is to know what is being used in the pool system. After the devices are selected you can then set valves for the appropriate features and use the “Manual” mode to measure flow rates for the types or series of devices that require flow. When an appropriate flow rate or rates are found for a device or series of devices, you should note that flow rate for programming later.

Note: If the pool system uses a filter, always monitor pressure at the filter when changing the speed (RPM) or flow (GPM) from the dump control panel.

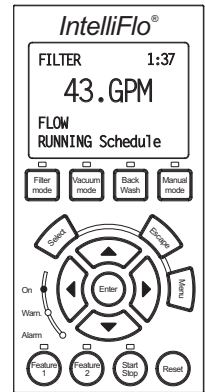

Manual Mode

Operating the pump in manual mode is typically used for service and testing purposes only.

To operate the pump in manual mode:

1. Ensure that the green power LED is on.
2. Press the **Manual** button.
3. Use the **Up** and **Down** arrow buttons to view the current power, actual speed and flow:
 - **Power Menu** (Watts): Displays current power to the motor shaft in continuous watts
 - **Actual Speed** (RPM): Displays RPM speed when flow and RPM control is used
 - **Actual Flow** (GPM): Displays actual flow when using flow control
 - **Set Speed** (RPM): Set the pump to run at a continuous speed
 - **Set Flow** (GPM): Set the pump in flow control to allow the pump to change speed to manage the flow rate based on system changes

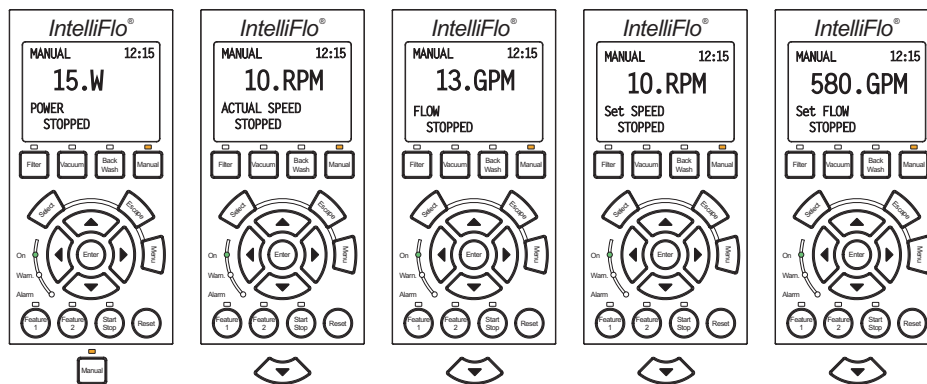

Note: No sensors except the flow control will work while in “Manual” mode. Suction Blockage will not work in this mode.

Manual Mode (Continued)

To change the Set Flow and Set Speed features:

1. Ensure that the green power LED is on.
2. Press the **Manual** button (LED is on).
3. **Set Flow:** Use the **Up** and **Down** arrow buttons to select **Set Flow**, then press the **Select** button to edit the setting.
4. To change the setting, press the **Left** and **Right** arrows to select which digit to modify, then use the **Up** and **Down** arrows to change the selected digit. The preset flow values can be set to 15 to 130 GPM (default 50 GPM).
5. When you are done, press the **Enter** button to save the changes. To cancel any changes, press the **Escape** button to exit edit mode without saving.
6. **Set Speed:** Use the **Up** and **Down** arrows to select **Set Speed**, then press the **Select** button to edit the setting. The preset speed can be set to 400 to 3450 RPM maximum (default 1000 RPM).

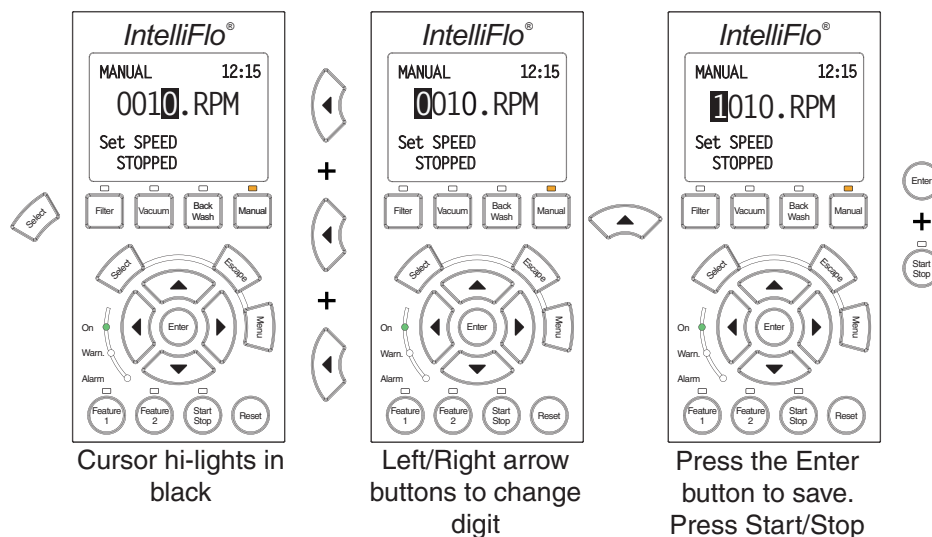

7. To change the setting, press the **Left** and **Right** arrows to select which digit to modify, then use the **Up** and **Down** arrows to change the selected digit.
8. When you are done, press the **Enter** button to save the changes. To cancel any changes, press the **Escape** button to exit edit mode without saving.
9. Press the **Start/Stop** button (LED is on) to run the IntelliFlo® VF Variable Flow Pump in "Manual" mode (LED is on). The pump will start and control the flow or speed using the last settings made. After the button is pressed, the display shows "Running." To stop the pump, press the **Start/Stop** button (LED is off). The display will show "Stopped."

Note: While the pump is running in Manual mode, you can view the current power consumption and what actual speed is being used.

Manual Mode (Continued)

10. Change Flow and Speed settings while the IntelliFlo® VF Variable Flow Pump is running:

The **Set Flow** and **Set Speed** settings can be changed on the fly while the pump is running. To change the flow and speed settings, perform steps 3 through 8.

- When “Set Flow” is used the pump will prime then ramp to the current flow rate.
- It takes the pump about 60 seconds to two minutes to find a flow rate after it is primed. This is best seen in Actual Speed status display.
- While changing the Set Flow setting, the pump will re-prime after a value is changed.
- While changing the Set Speed setting, the pump will immediately ramp to the current speed.

11. To stop the pump, press the **Start/Stop** button.

IntelliFlo Pump Control Panel Menu

Use the control panel menu to setup and configure IntelliFlo pump.

To access the menu features:

- Ensure that the pump is stopped. Press the **Menu** button. Use the **Up** or **Down** arrow button to scroll through the menu items. Use the **Select** button to select a menu item. Press the **Enter** button to save a setting. Press the **Escape** button to move up a level from a selected menu item.

Menu Structure

The IntelliFlo pump menu structure is shown on the following page.

IntelliFlo Pump Control Panel with IntelliComm® Communication Center or IntelliTouch® Control System

- The IntelliFlo pump control panel remains active when the pump is connected to an IntelliComm communication center. For more information see page 29.
- The IntelliFlo pump control panel is disabled when the pump is communicating with an IntelliTouch control system. “DISPLAY NOT ACTIVE!” will be displayed. For more information see page 31.

Menu Structure

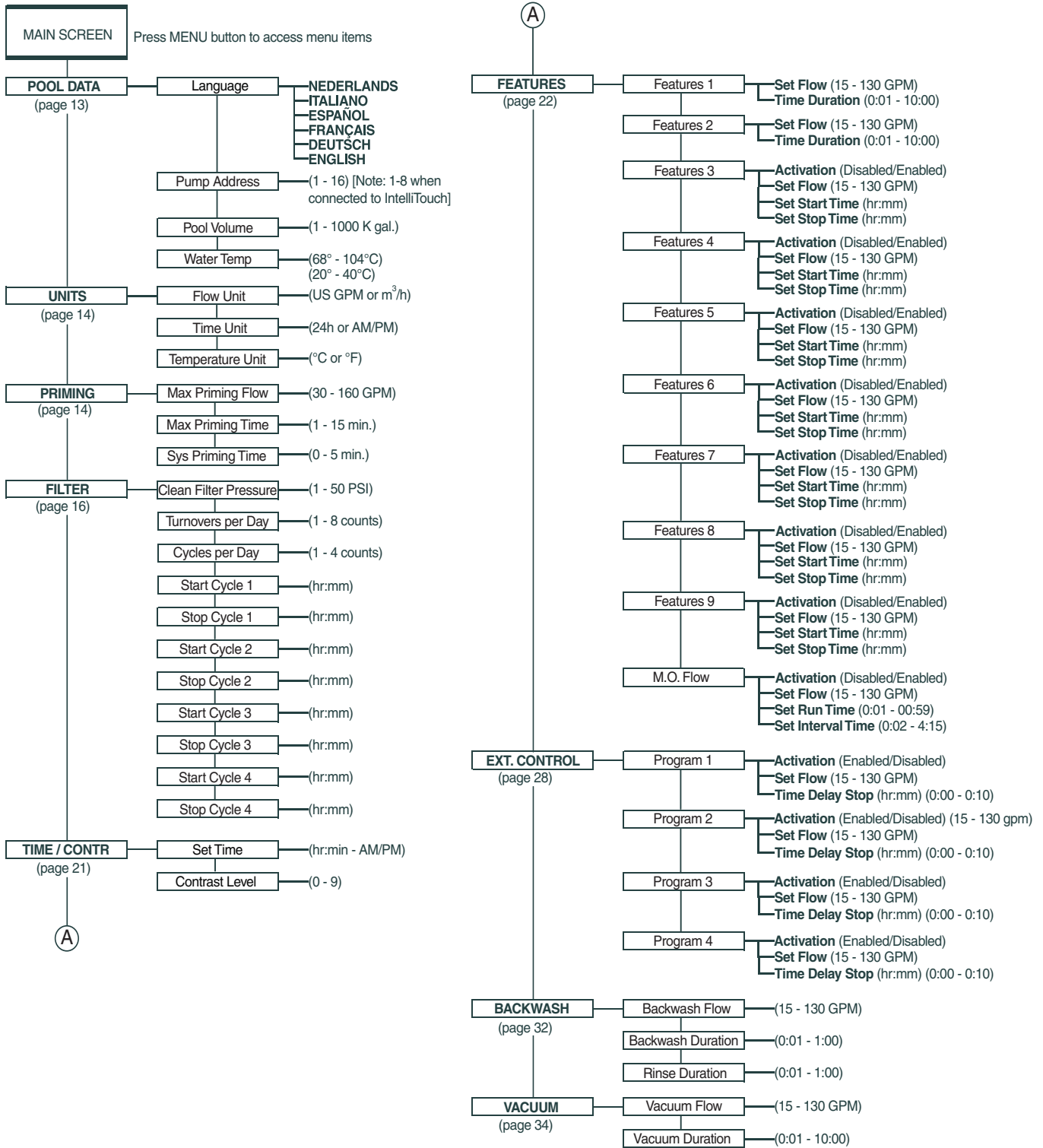

Pool Data Mode

Use the Pool Data menu to configure the IntelliFlo® VF Variable Flow Pump for the pool and spa system. From this menu you can set an address for the pump when connected to an IntelliTouch® Control System, set the volume of pool water, in 1000's of gallons (kgal) and estimated pool water temperature.

To access the Pool Data menu:

1. Ensure that the green power LED is on and the pump is stopped.
2. Press the **Menu** button.
3. Press the **Up** and **Down** arrow buttons to scroll through the menu items. Press the **Select** button to access the “Pool Data” menu.
4. **To enter the pump volume (pool size):** Press the **Select** button to access “Pool Volume” setting. To enter the pool volume setting, see step 7.

The “Pool Volume” value is expressed as 1000's of gallons (Kgal). Enter from 1 to 1000 Kgal for the pool volume. The volume number can be a close estimate, although the more accurate the better the turns will be done when employing filter mode. Filter mode uses this value in coordination with the parameters from Filter mode to sustain turn rates, flows, and times.

5. **To set the water temperature:** Use the **Up** and **Down** arrows to select “Water Temperature”. To set the water temperature, see step 7.

Enter the current water temperature from 68° F - 104° F (Default 75° F.) The “Water Temp” is only for the accuracy of the flow sensor. Temperature accuracy is not critical, just enter an approximate temperature. When the pump is connected to an IntelliTouch control system, water and air temperature information is provided by the system sensors. The flow reading on the pump is -0 / +2 GPM. The closer the temperature to the actual temperature, the more accurate the flow reading on the pump's control panel LCD will be while it's running.

6. **To enter the pump address:** Press the **Select** button to access the “Pump Address” setting. To enter the pump address, see step 7.

This setting is only used if the pump is connected to the control system. The “Pump Address” identifies the pump number (1-16) that is displayed on the control system control panel for programming. For example, if there are multiple IntelliFlo pumps, pump address 1 can be name as “Spa Pump,” in the IntelliTouch control system control panel. The IntelliTouch control system can address and control up to eight different pumps using the RS-485 COM port connection.

Note: IntelliFlo pumps cannot be connected in series with other pumps. Check valves must be used when an IntelliFlo pump is used in parallel with other pumps.

7. Press the **Select** button to change the current setting.
8. To enter a new setting, press the **Left** and **Right** arrows to select which digit to modify, then use the **Up** and **Down** arrows to change the selected digit.
9. When you are done, press the **Enter** button to save the changes. To cancel any changes, press the **Escape** button to exit edit mode without saving.

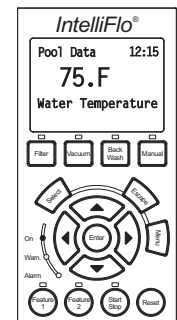
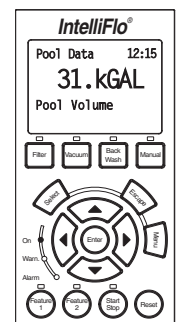
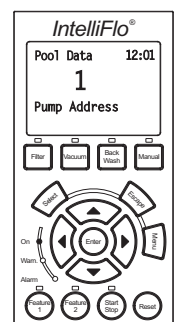
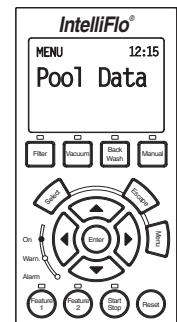

Priming Mode

To “prime” a pump means filling the pump and suction pipe with water. This process evacuates the air from all the suction lines and the pump. It may take several minutes to prime depending on the depth of water, pipe size and length. It is easier to prime a pump if you allow all the air to escape from the pump and pipes. The water cannot enter unless the air can escape. Pumps do not hold prime, the pool piping system has that task.

Priming is a function used every time the motor is started with a flow as reference. The “Priming Flow” function ensures the proper operation of the pump. The “System Priming Time” function ensures proper operation of the whole pool system. When the pump is priming, the control panel LCD displays “Priming” and then for a moment displays “Primed” when priming is complete.

CAUTION

To avoid permanent damage to the IntelliFlo® VF Variable Flow Pump, before starting the system, fill the pump housing strainer with water so that the pump will prime correctly. If there is no water in the strainer the pump will not prime.

Priming Menu

To enter maximum priming flow (GPM):

1. Ensure that the green power LED is on and the pump is stopped.
2. Press the **Menu** button. “Pool Data” is displayed.
3. Press the **Up** or **Down** arrows to select the “Priming” menu.
4. **To set the Max Priming Flow (GPM):** Press the **Select** button to access the “Max Priming Flow” setting. To enter the maximum flow range (GPM) during the priming cycle, see step 7.

The “Max Priming Flow” value is entered as gallons per minute (GPM), from 30 to 160 GPM. The default is 55 GPM. The “Max Priming Flow” is a critical parameter for the pool and equipment. Every time the pump starts this parameter will negotiate the maximum flow of the pump. If the flow is too high, equipment damage can occur. If the flow is too low the pump will not prime. This “flow” is system dependent and may require adjustment. The pump will never flow more than this parameter is set to, however, it is common for the pump to ramp up and down quickly while priming. Always try to keep this flow as low as possible for cost savings and safety.

5. **To set the Max Priming Time:** Press the **Select** button to access the “Max Priming Time” setting. To enter the maximum time for priming before “PRIMING ERROR”, see step 7 on the following page.

The “Max Priming Time” value is entered in minutes, from 1 to 15 minutes. The default is 15 minutes. Use this parameter to set the time that you want IntelliTouch® Control System to try and prime before it reports an error. Remember that the the pump will attain prime every time it starts and goes through this cycle. The pump’s mechanical seal can withstand about 15 minutes before severe damage occurs. You can set this range between 1 minute to 15 minutes. The lower the time the quicker you will get a priming error if the system is difficult to prime. A well plumbed pool without having the strainer removed should prime in less than 30 seconds. If the strainer has been removed for cleaning and a substantial amount of air is in the system it should prime in about 60 to 90 seconds on the average, however, all systems will be different.

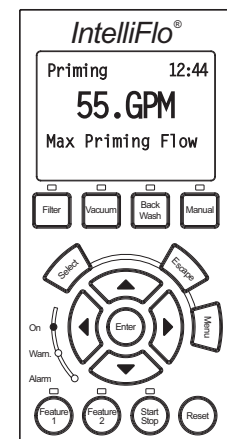
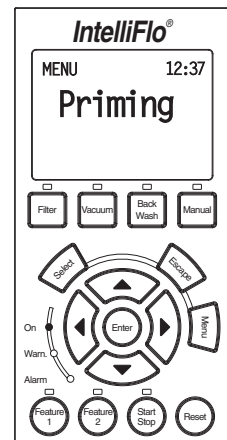

Priming Mode (Continued)

6. **To set the System Priming Time:** Press the **Select** button to access the “System Priming Time” setting. After the IntelliFlo® VF Variable Flow Pump is primed it will take sometime before the system is primed. This time is called “System Priming Time”. To enter the system priming time, see step 7.

The “System Priming Time” value is entered in minutes, from 0 to 5 minutes. The default is 0 minutes. Remember that the average unit will prime in a short period of time because the pump has the ability to monitor itself to make sure it is primed. “System Priming Time” is for systems that require high flows that priming flow can provide but it is deemed that more time is needed to fully relieve all the air. The builder can program a predetermined amount of time, up to 5 minutes, to aid in relieving the air from difficult filters or complex vertical plumbing. The “System Priming Time” should only be used where large air traps become problems within the system. The display will inform the user when this is engaged and when it is finished during the priming cycle at each start up cycle.

7. Press the **Select** button to change the current value.
8. To change the value, press the **Left** and **Right** arrows to select which digit to modify, then use the **Up** and **Down** arrows to change the selected digit.
9. When you are done, press the **Enter** button to save the changes. To cancel any changes, press the **Escape** button to exit edit mode without saving.

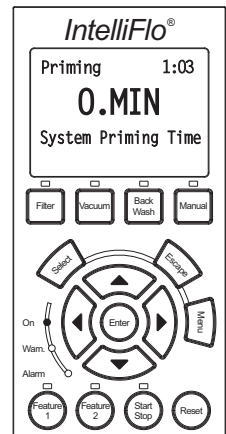
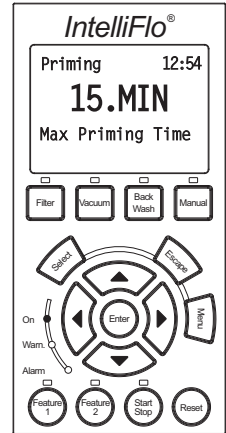

Filter Mode

The IntelliFlo® VF Variable Flow Pump will calculate the required flow rate based on pool size, clean filter pressure, pool turns per day and cycles per day, and will control the motor speed to keep a constant flow. The filter mode can run cycles, power save or features. The pump's internal scheduler will keep track of which function to run. The IntelliFlo pump is constantly monitoring the filter, when it detects that the system is dirty, it will display an "Alert - Service System Soon" message on the control panel display. The user must then clean the filter by performing a Backwash cycle (see page 33).

Filter Menu

To access the Filter menu settings:

1. Ensure that the green power LED is on and the pump is stopped.
2. Press the **Menu** button. Press the **Up** or **Down** arrows to select the "Filter" menu. Press the **Select** button, "Clean Filter Pressure" is displayed.
3. **To set the Clean Filter Pressure:** Press the **Select** button to access the "Clean Filter Pressure" setting. To edit the pressure setting, see step 6 on the following page.

This parameter can be set from 1 PSI to 50 PSI. The average setting should be between 10 PSI and 20 PSI for most pools and filters. The entered PSI value splits the percentage meter for the filter. The "Service System Soon" alert is activated by the entered PSI value. When this value is reached the pump stops monitoring flow rates and starts managing pressure. The value represents the change in pressure over time from start up (system clean) to present day (system getting dirty). The changes can come from anywhere in the system, for example clogged skimmers or pots in pumps. For more information, refer to "Clean Filter Pressure" on page 19.

4. **To set the Turnovers Per Day:** Press the **Select** button to access the "Turnovers Per Day" setting. To edit this setting, see step 6 on the following page.

This setting is the number of times you wish to turn over the water that is setup in the "Pool Volume" part of the "Pool Data" menu (see page 13).

You can set up to eight turns per day. It is recommended that one turn per day for energy conservation and requirements be performed for most common residential pools. Refer to sanitizer recommendation for additional information.

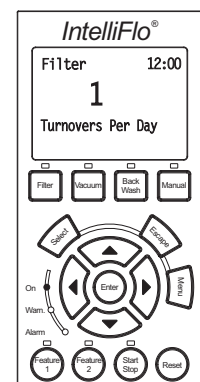
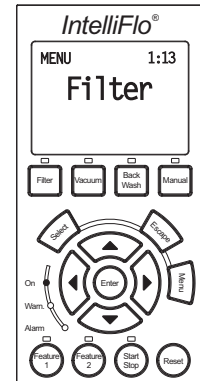

Filter Mode (Continued)

- To set the **Cycles Per Day**: Press the **Select** button to access the “Cycles Per Day” setting. To edit this setting, see step 6.

The IntelliFlo® VF Variable Flow Pump uses the Cycles Per Day parameter to calculate how much time it has to complete its filter job. You can program up to four start and stop cycles per day. The more time the pump is given to operate the less power and flow will be needed for turning over the pool.

Note: Consumers in certain areas are charged lower energy rates at non-peak hours. To take advantage of this, the pump can be programmed to run at any time of the day. The extremely quiet operation of the pump makes it feasible to operate during the early morning or late at night. The easiest and best way to optimize flow during filter cycles is by adding or subtracting cycle time. This way, the desired flow effect, for example, skimming action, can be achieved while maintaining the desired water turnover rate.

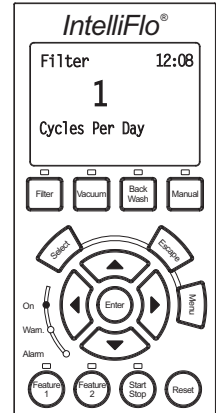

- Press the **Select** button to change the current value.
- To change the value, press the **Left** and **Right** arrows to select which digit to modify, then use the **Up** and **Down** arrows to change the selected digit.
- When you are done, press the **Enter** button to save the changes. To cancel any changes, press the **Escape** button to exit edit mode without saving.

Programming Cycles Per Day

Each cycle has two screens, one for the “Start Cycle” and one for “Stop Cycle”. The following examples shows one for the cycle start/stop time. Only one cycle is entered in the “Cycles Per Day” parameter.

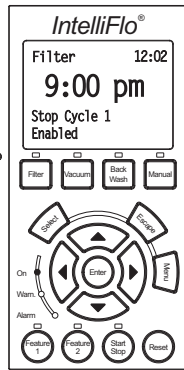
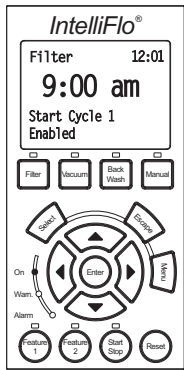

Start and Stop Cycle is displayed

Enabled or disabled is displayed depending on how many cycles are selected

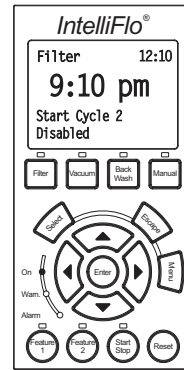

This screen shows the filter cycle as “Disabled” for a start/stop cycle (Cycles Per Day programmed to 1). These screens will still display even if they are not enabled.

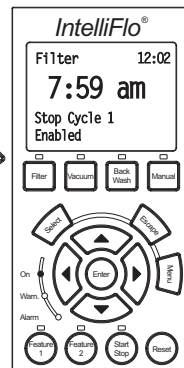
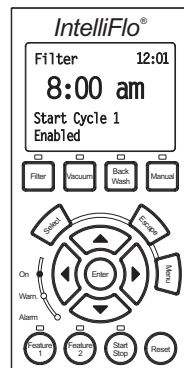

This example will run the pump for 24 hours. Start and Stop Cycle is displayed

Enabled or disabled is displayed depending on how many cycles are selected

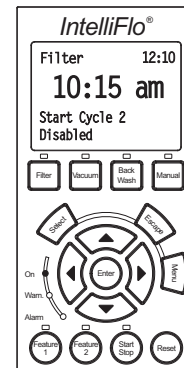

This screen shows the filter cycle as “Disabled” for a start/stop cycle (Cycles Per Day programmed to 1). These screens will still display even if they are not enabled.

Filter Mode (Continued)

Filter Cycle Settings

Note: The control panel is disabled when the IntelliFlo® VF Variable Flow Pump is communicating with an IntelliTouch® Control System. “DISPLAY NOT ACTIVE!” will be displayed.

NAME	VALUE	DESCRIPTION
Turnovers Per Day	1-8 (Default 1)	The number of times per day the volume of water setup in “Pool Volume” will be moved.
Cycles per Day	1-4 Cycles (Default 1)	The number of cycles (start and stop) the IntelliFlo must do per day.
Clean Filter Pressure	1-50 PSI (Default 14 PSI)	The differential pressure from the 0-pressure to 100% filter status.
Start Cycle 1	1:00 -12:59 HH.MM am/pm (Default 9:00 am)	Start time for cycle 1 (if start and stop is the same time the IntelliFlo will run 24*7).
Stop Cycle 1	1:00 -12:59 HH.MM am/pm (Default 9:00 pm)	Stop time for cycle 1 (if start and stop is the same time the IntelliFlo will run 24*7).
Start Cycle 2	1:00 -12:59 HH.MM am/pm (Default 9:10 pm)	Start time for cycle 2. If “Cycles per day” is below 2, “OFF” will be shown in the display and data cannot be entered.
Stop Cycle 2	1:00 -12:59 HH.MM am/pm (Default 9:20 pm)	Stop time for cycle 2. If “Cycles per day” is below 2, “OFF” will be shown in the display and data cannot be entered.
Start Cycle 3	1:00 -12:59 HH.MM am/pm (Default 9:30 pm)	Start time for cycle 3. If “Cycles per day” is below 3, “OFF” will be shown in the display and data cannot be entered.
Stop Cycle 3	1:00 -12:59 HH.MM am/pm (Default 9:40 pm)	Stop time for cycle 3. If “Cycles per day” is below 3, “OFF” will be shown in the display and data cannot be entered.
Start Cycle 4	1:00 -12:59 HH.MM am/pm (Default 9:50 pm)	Start time for cycle 4. If “Cycles per day” is below 4, “OFF” will be shown in the display and data cannot be entered.
Stop Cycle 4	1:00 -12:59 HH.MM am/pm (Default 10:00 pm)	Stop time for cycle 4. If “Cycles per day” is below 4, “OFF” will be shown in the display and data cannot be entered.

Based on “Pool Volume”, “Turnovers per day” and the total number of hours for Cycle 1 + 2 + 3 + 4 the flow must be calculated:

$$\text{Flow} = \frac{\text{“Pool Volume”} \times \text{“Turnovers per day”}}{\text{Cycle1} + \text{Cycle2} + \text{Cycle3} + \text{Cycle4}}$$

Note: Only enabled cycles are included in the calculation

Filter Mode (Continued)

Clean Filter Pressure Example

The following example shows the “Clean Filter Pressure” set to 14 PSI.

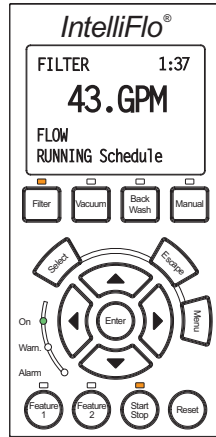

Pump newly installed and system run for the first time

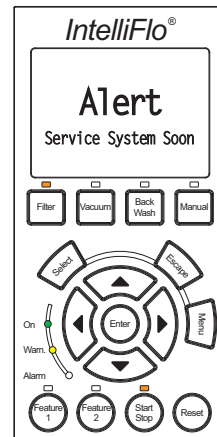
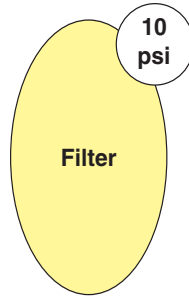

12 months later filter attains 24 psi of internal pressure which is a 14 psi increase

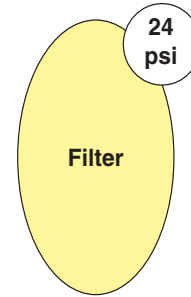

Alert Status

Once the “Alert” is triggered the yellow warning LED is lit and “Alert” is displayed on the screen. The IntelliFlo® VF Variable Flow Pump will reduce speed to maintain 14 PSI of head pressure and stop managing flow. Note the following:

- The % clean filter pressure has reached 100%.
- If parameter is set to 14 PSI every 10% on the display is 1.4 psi on the filter.
- If the parameter is set to 10 PSI every 10% on the display is 1 psi on the filter.
- The filter must be cleaned or backwashed to reduce the pressure. Even if the system has a cartridge filter the pump must be started in Backwash Mode with a clean filter to reset the fault and “zero” the pump’s filter status reading.

Note: For a complete list of IntelliFlo pump alert warnings, refer to “Alerts and Warnings” on page 45.

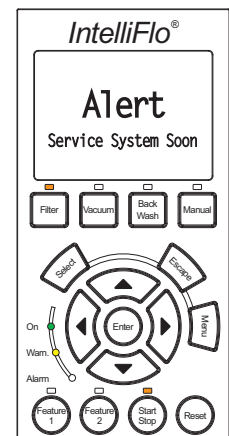

Filter Mode (Continued)

Using Filter mode with Features mode

The IntelliFlo® VF Variable Flow Pump will start and stop at programmed filter cycles 1-4. The filter cycles can be overridden by “Feature” (3-9 only) as shown in the example below. This may cause the required filter volume to be achieved earlier.

The “Feature” function is allowed to take control during “Filter” mode. When the feature function stops, the pump will continue in “Filter” mode. If only Feature 3-9 is active during a filter cycle, the pump will calculate a new filter cycle.

Example: The pump was suppose to run in Filter mode from 1:00 to 11:00 to turnover 10 GPM for 10 hours (10 GPM 10 Hours= 6 kGal).
But because Feature 3 has been running 20 GPM for 4 hours (20 GPM 4 Hours= 4,8 kGal), the pump must stop at 8:00 because; 10 GPM* 3 Hours + 20 GPM 4 Hours= 6,6 kGal.

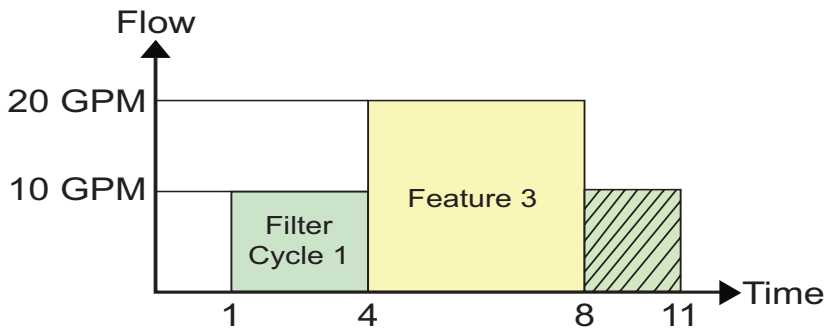

“Feature” 1 and 2 do not have time-of-day functions and do not affect the filter cycle time. The active time for “Feature” 1 and 2 will not be calculated into the reduced cycle time as shown in the above example.

Filter Mode and Flow Control

The Filter Mode feature provides the ability of overcoming head pressure loss to provide the required flow through the plumbing. The flow that the unit can provide is limited by the installed plumbing. If more flow is demanded than the the pump can provide, it will ramp to full speed and create pressure.

The following example shows a ramp as flow increases from 50 to 75 GPM.

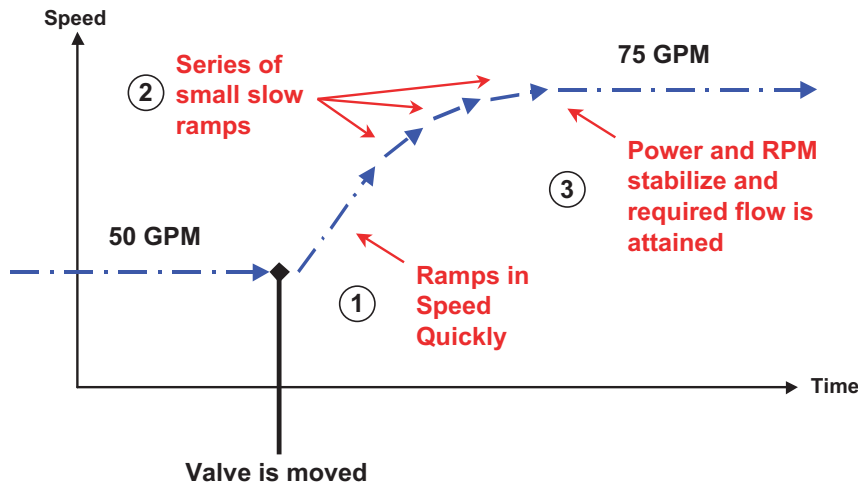

Time and Contrast Menu

Use the “Time and Contr” menu settings to set the IntelliFlo® VF Variable Flow Pump’s system clock and to adjust the control panel display contrast. The pump system clock controls all scheduled start and stop times, functions, and programmed cycles. The system clock can store the correct time for up to 96 hours after power is shut off. After 96 hours the clock must be reset to the correct time.

Setting System Time

To set the pump’s system clock:

1. Ensure that the green power LED is on and the pump is stopped.
2. Press the **Menu** button. “Pool Data” is displayed.
3. Press the **Up** or **Down** arrows and select “Time/Contr.”
4. Press the **Select** button to access “Time/Contr” setting.
5. Press the **Select** button to change the current minutes and hour.
6. To change the minute and hour digits, press the **Left** and **Right** arrow buttons to select which digit to modify, then use the **Up** and **Down** arrow buttons to change the selected digit. Note, that the hours selection is from 01 to 11 for A.M. and P.M. The system time is displayed on the main screen, A.M. and P.M. are not displayed.
7. Press the **Enter** button to save the setting.

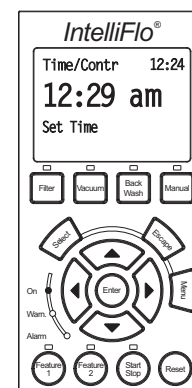
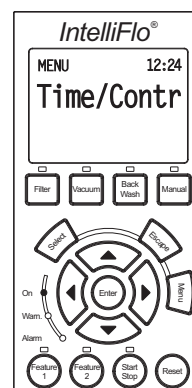

Setting the LCD Backlight Contrast

To change the contrast of the control panel display :

1. Ensure that the green power LED is on and the pump is stopped.
2. Press the **Menu** button. “Pool Data” is displayed.
3. Press the **Up** or **Down** arrows and select “Time/Contr.”
4. Press the **Select** button.
5. Press the **Up** or **Down** arrows and select “Contrast Level.”
6. Press the **Select** button. The contrast levels are 0 to 9. Avoid using 0 unless screen is unreadable in bright sun
7. Press the **Enter** button to save the setting.

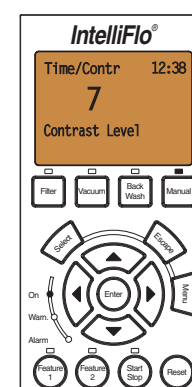
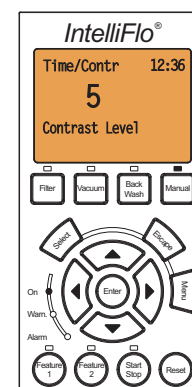

Features Mode

The Feature mode can be used with water features such as spa, cleaner, waterfalls, etc. You can schedule start and stop times for each feature. All Features are operated using Flow control. The Feature mode and Filter mode are run simultaneously. The three types of features are; Features 1 & 2, Features 3 - 9 and M.O. Flo:

Features 1 and 2

Feature 1 and Feature 2 run for a pre-defined duration with a specifically set flow. If Feature 1 or Feature 2 buttons are pressed, all other Features are temporarily deactivated. Feature 1 or Feature 2 cannot be used in Backwash Mode. Features 1 and 2 have a higher priority than the pre-programmed Features 3-9. After the preset duration time for the Feature 1(2), the IntelliFlo® VF Variable Flow Pump will switch back to the “Filter” mode if the pump was in “Filter” mode when the Feature 1 (2) button had been pressed. After the preset duration time for the Feature 1(2), the pump will switch back to the “Manual” mode if pump was in “Manual” mode when the Feature 1 (2) button had been pressed.

Features 3-9

Features 3 through 9 are only active in Filter mode. These features run a set flow for a specified time. The Features 3-9 can not overlap.

M.O. Flo

The M. O. Flo feature automatically increases the pump flow to allow the system heater to check the water temperature and switch on if necessary. This feature is only active when the pump is running a filter cycle. Once the heater checks for heat and discovers it must fire it will send a signal back to the pump to go into “Heater” mode. M.O. Flo only works during the “Filter” mode selected time cycles.

Features Mode (Continued)

Feature Settings

Name	Value	Description
F1-9 and M.O. Flo Set Flow	15-130 GPM (Default 50 GPM)	Pre-set flow for feature 1 - 10
F3-10: Activate Feature	Enabled / Disabled (Default Disabled)	If value in line 1 is set Enabled the Feature will be active. If value in line 1 is set Disabled the Feature will be turned off.
F1-2: Duration Time	0-10 Hours (Default 00:01)	The time duration for feature 1 and 2. The duration must be selected for Feature 1 and 2.
F3: Start time	12:00 AM - 11:59 PM (Default 06:00 am)	Start time for feature 3
F3: Stop time	12:00 AM - 11:59 PM (Default 06:10 am)	Stop time for feature 3
F4: Start time	12:00 AM - 11:59 PM (Default 06:20 am)	Start time for feature 4
F4: Stop time	12:00 AM - 11:59 PM (Default 06:30 am)	Stop time for feature 4
F5: Start time	12:00 AM - 11:59 PM (Default 06:40 am)	Start time for feature 5
F5: Stop time	12:00 AM - 11:59 PM (Default 06:50 am)	Stop time for feature 5
F6: Start time	12:00 AM - 11:59 PM (Default 07:00 am)	Start time for feature 6
F6: Stop time	12:00 AM - 11:59 PM (Default 07:10 am)	Stop time for feature 6
F7: Start time	12:00 AM - 11:59 PM (Default 07:20 am)	Start time for feature 7
F7: Stop time	12:00 AM - 11:59 PM (Default 07:30 am)	Stop time for feature 7
F8: Start time	12:00 AM - 11:59 PM (Default 07:40 am)	Start time for feature 8
F8: Stop time	12:00 AM - 11:59 PM (Default 07:50 am)	Stop time for feature 8
F9: Start time	12:00 AM - 11:59 PM (Default 08:00 am)	Start time for feature 9
F9: Stop time	12:00 AM - 11:59 PM (Default 08:10 am)	Stop time for feature 9
F10: M.O.Flo Run time	0-10 minutes (Default 1 min)	“Run time” is the time for which the M.O. Flo function is running at the set flow
F10: M.O.Flo Interval time	0 - 255 minutes (Default 60 min)	“Interval time” is the time between activation of the “set flow” value for M.O. Flo

Features Mode (Continued)

The functions of the Features groups are shown below:

How to set up the Feature 1 or 2 (Flow and Duration) mode

To access the Features menu:

1. Ensure that the green power LED is on and the IntelliFlo® VF Variable Flow Pump is stopped.

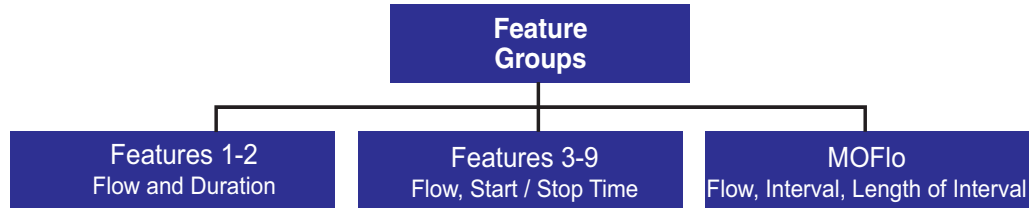

2. Press the **Menu** button. Press the **Up** or **Down** arrows to select the “Features” menu. Press the **Select** button to access the Feature 1 menu settings. The Features 1 menu setting is displayed.
3. **To set the flow rate for Feature 1 or 2:** Press the **Select** button to access the Feature 1 “Set Flow” setting. To edit the flow rate (GPM) setting, see step 6.
4. **To set the duration for Feature 1 or 2:** Press the **Select** button to access the Feature 1 “Duration” setting. To edit the time (hours and minutes) setting, see step 6.
5. Press the **Select** button to change the current value of Feature 1 or 2.
6. To change the value, press the **Left** and **Right** arrows to select which digit to modify, then use the **Up** and **Down** arrows to change the selected digit.
7. When you are done, press the **Enter** button to save the changes. To cancel any changes, press the **Escape** button to exit edit mode without saving.

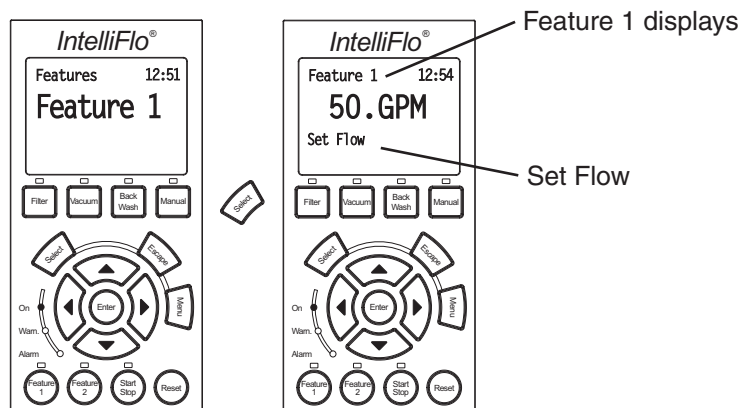
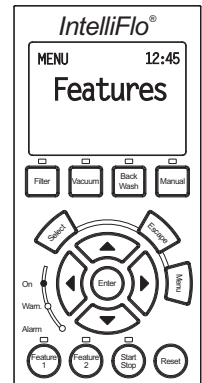

Features 1 – 2 (Flow and Duration)

To run Feature 1 or 2 (Flow and Duration)

1. Press the **Feature 1** or **Feature 2** button, then press the **Start/Stop** button. The active feature LED will be on until the process is finished.
2. The Features screen will then start to subtract time in minutes from your duration or you can scroll using the **Up** or **Down arrow** buttons to see the power, speed, or flow status.

The following screen shown Feature 1 initiated:

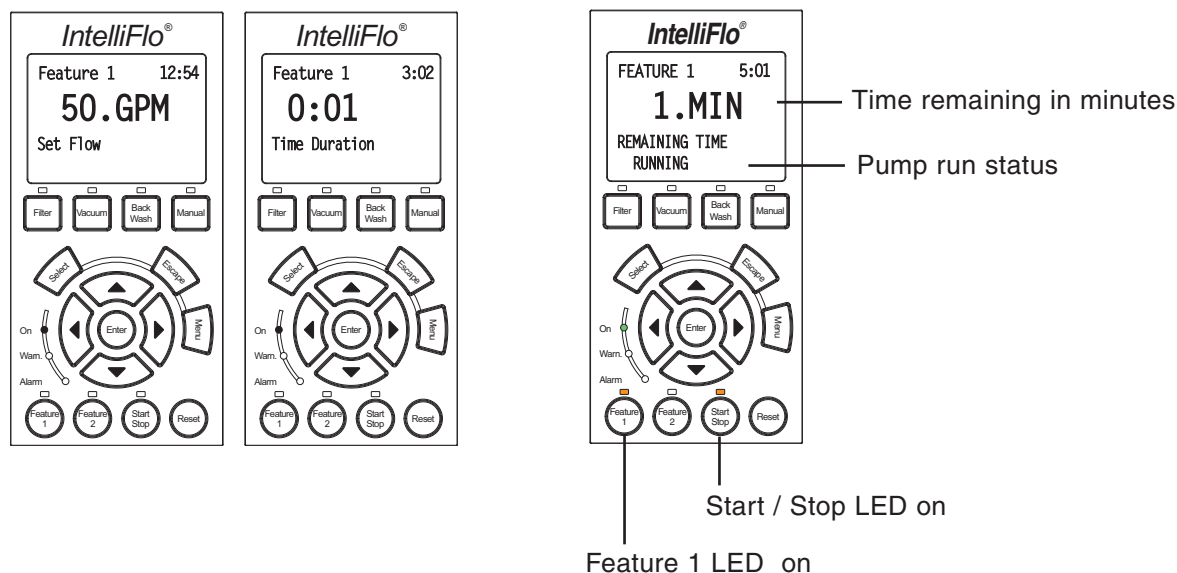

Features 3 – 9 (Flow, Start/Stop Time)

Features 3 – 9 affect the “Filter” mode as shown on page 20.

Features 3 – 9 are programmed by a flow rate and a start/stop time and are automatically initiated. They are controlled by the time of day. All alerts and alarms are active in Feature mode. Features 3 – 9 must be enabled in its menu.

Enabling Features 3 – 9

To use any Features 3 – 9 it must be first enabled. If it is not enabled, it will not work with the parameters in the “Set Flow” and “Set Start Time” and “Set Stop Time” settings. Features 3 – 9 are each programmed in the same way. Three parameters are required after Enabling; Flow, Start, and Stop.

To use the Feature 3 settings; Enabled, Set Flow, Set Start Time, and Set Stop Time:

1. Ensure that the green power LED is on and the IntelliFlo® VF Variable Flow Pump is stopped.
2. Press the **Menu** button. Press the **Up** or **Down** arrows to select the “Features” menu. Press the **Down** arrow button to select **Feature 3**. Press the **Select** button to access the Feature 3 menu settings. The Features 3 menu setting is displayed.

Enabling Features 3 - 9 (Continued)

3. **To enable Feature 3:** Press the **Select** button then the **Down arrow** button to select **Enabled** if not already selected. Press the **Enter** button to save the setting.
4. **To set the flow rate for Feature 3:** Press the **Down arrow** button to select “Set Flow” setting. Press the **Select** button to access the setting. To edit the flow rate (GPM) setting, see step 6.
5. **To set the start and stop time for Feature 3:** Press the **Down arrow** button to select “Start Time” or Stop Time” setting. Press the **Select** button to access the setting. To edit the start and stop time, see step 6.
6. Press the **Select** button to change the current value.
7. To change the value, press the **Left** and **Right** arrows to select which digit to modify, then use the **Up** and **Down** arrows to change the selected digit.
8. When you are done, press the **Enter** button to save the changes. To cancel any changes, press the **Escape** button to exit edit mode without saving.

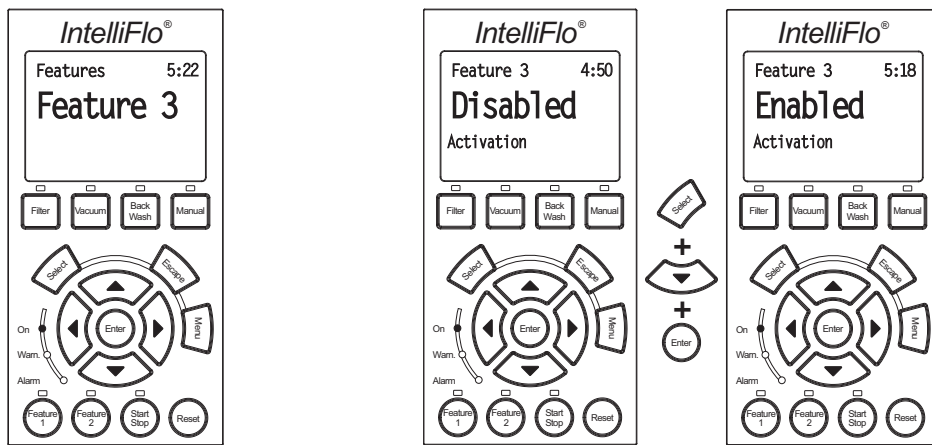

Filter Cycle Examples

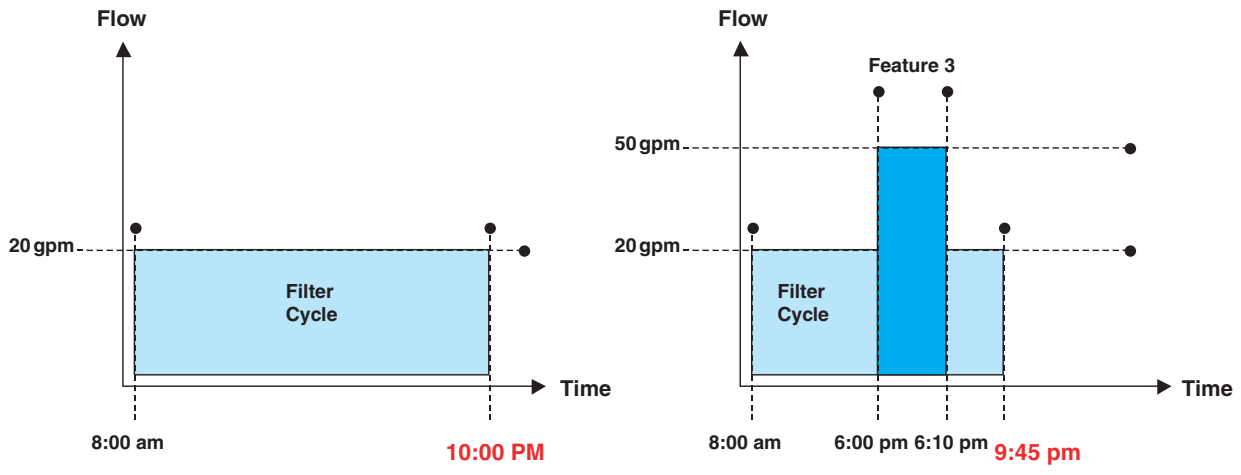

Original Filter Cycle w/No Timed Feature

New Flow/Time Optimized Filter Cycle

Note: Refer to page 20 for further explanation.

M.O. Flo (Modulation Output Flow)

M.O. Flo (Modulated Output Flow) is specifically designed for Pentair branded heaters with an IntelliComm® Communication Center, although it can be used for other functions, such as water effects. This feature allows you to have flexibility in flow control if the filter cycle flow is less than needed for certain devices. M.O. Flo also allows you to program intervals of flow separated by a specific duration which can be useful for water effects.

To setup the M.O. Flo option:

1. Ensure that the green power LED is on and the IntelliFlo® VF Variable Flow Pump is stopped.
2. Press the **Menu** button. Press the **Up** or **Down** arrows to select the “Features” menu. Press the **Down arrow** button to select **M.O. Flo**. Press the **Select** button to access the M.O. Flo menu settings. The M.O. Flo “Activation” setting is displayed.
3. **To enable M.O. Flo:** Press the **Select** button then the **Down arrow** button to select **Enabled** if not already selected. Press the **Enter** button to save the setting.
4. **To set the flow rate for M.O. Flo:** Press the **Down arrow** button to select “Set Flow” setting. Press the **Select** button to access the Manual setting. To edit the flow rate (GPM) setting, see step 6.
5. **To set the run and interval time for M.O. Flo:** Press the **Down arrow** button to select “Set Run Time” or “Set Interval Time” setting. Press the **Select** button to access the setting. To edit the start and stop time, see step 6.
6. Press the **Select** button to change the current value.
7. To change the value, press the **Left** and **Right** arrows to select which digit to modify, then use the **Up** and **Down** arrows to change the selected digit.
8. When you are done, press the **Enter** button to save the changes. To cancel any changes, press the **Escape** button to exit edit mode without saving.

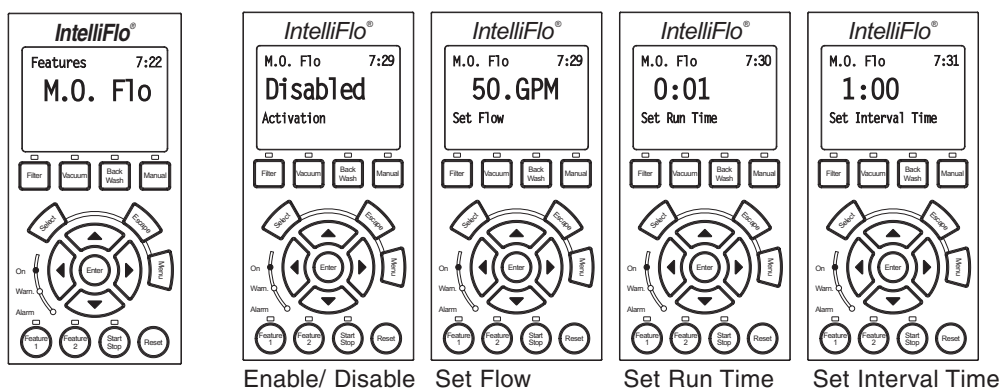

The following graphical representation shows when the M.O. Flo feature is enabled.

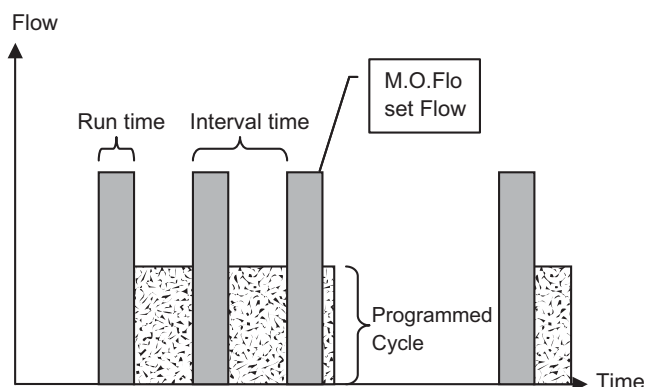

External Control with IntelliComm® Communication Center

The IntelliFlo® VF Variable Flow Pump can be remotely controlled by the Pentair IntelliComm communication center using an optional communications cable (P/N 350122). The communication center provides four pairs of input terminal connections. These inputs are actuated by either 15 - 240 VAC or 15 - 100 VDC. Using the device's inputs, the pump's external control Programs 1-4 can be controlled.

If more than one input is active the highest number will be communicated to the pump the IntelliComm communication center will always communicate to pump address 1. The IntelliFlo pump control panel remains active when the pump is connected to the communication center.

The following table shows the wiring terminal descriptions for IntelliComm communication center.

External Control



IntelliComm Communication Center

Terminal number	Terminal name	Voltage	Maximum current	Phase type	Frequency
1-2	Power supply	100 - 240 VAC	100 mA	1 Input	50/60 Hz
3-4	Program 1	15 -240 VAC or 15 - 100 VDC	1 mA*	1 Input	50/60 Hz
5-6	Program 2	15 -240 VAC or 15 - 100 VDC	1 mA*	1 Input	50/60 Hz
7-8	Program 3	15 -240 VAC or 15 - 100 VDC	1 mA*	1 Input	50/60 Hz
9-10	Program 4	15 -240 VAC or 15 - 100 VDC	1 mA*	1 Input	50/60 Hz
11 12	RS-485 + Data: Yellow - Data: Green	-5 to +5 VDC	5 mA	1 Output	N/A
	Ground				

External Control (Continued)

Setting up External Control using IntelliComm® Communication Center

The IntelliComm communication center is activated by the device voltage when it switches on and off which in turn enables any one of the pump's Programs 1-4. When the signal stops, the IntelliFlo® VF Variable Flow Pump will default back to its cycle programming. The pump will always override to its largest command flow rate.

Note: The pump control panel remains active when the pump is connected to the communication center.

To access the Ext. Ctrl. menu:

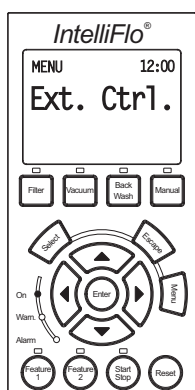

1. Ensure that the green power LED is on and the pump is stopped.
2. Press the **Menu** button. Press the **Up** or **Down** arrows to select the “Ext. Ctrl.” menu. Press the **Select** button to select “Program 1” menu settings.
3. Use the **Up** and **Down** arrow buttons to scroll through the programs; Program 1, Program 2, Program 3, and Program 4. Each program has three parameters, Enable/Disable, Flow (GPM), and Time Delay stop. When the program is active, it will display the program name on the screen. To edit a setting, see step 4.
4. Press the **Select** button to change the current value.
5. To change the value, press the **Left** and **Right** arrows to select which digit to modify, then use the **Up** and **Down** arrows to change the selected digit.
6. When you are done, press the **Enter** button to save the changes. To cancel any changes, press the **Escape** button to exit edit mode without saving.

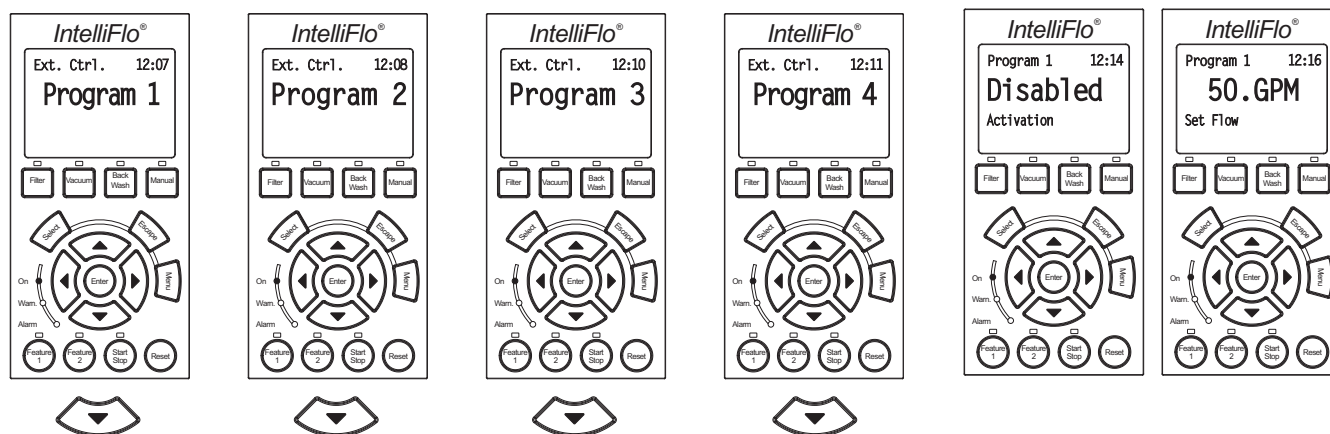

Controlling the IntelliFlo® Pump with the IntelliTouch® Control System

The IntelliFlo VF Variable Flow Pump can be controlled by an IntelliTouch control system via the RS-485 communication cable. In this configuration the control system starts and stops the pump. The IntelliTouch control system also rewrites many of the parameters in the IntelliFlo pump drive's memory, such as the filter cycle start and stop times, pool size and the clock. The transfer of this data takes several seconds and causes a delay from when the command is given from the IntelliTouch control system indoor control panel until the pump physically responds. Frequently, these changes to the IntelliFlo pump parameters will cause the pump to stop while it recalculates internal parameters and then restart. This happens automatically but may take 1-2 minutes to complete.

The pump's LCD control panel is disabled when communicating with the IntelliTouch control system and "DISPLAY NOT ACTIVE" will be displayed. Note that control system will not start communicating with the pump until the pump is assigned an IntelliTouch control system circuit name. For more information, refer to the IntelliTouch Control System User's Guide (P/N 520102).

Connecting the IntelliFlo Pump to IntelliTouch Control System

Connection from the pump to the IntelliTouch control system is via the optional two-wire cable (P/N 350122). The cable pinout is shown on page 31.

To connect the IntelliFlo pump cable to the IntelliTouch control system load center:

1. **CAUTION** - Switch the main power off to the IntelliTouch control system load center.
2. Unlatch the control system load center front door spring latches, and open the front door.
3. Remove the cover-panel screws securing the high voltage cover-panel, and remove it from the enclosure.
4. Loosen the two control panel access screws and fold down the outdoor control panel.
5. Insert the two-wire cable into plastic grommet on the bottom of the enclosure and route the wire up through the low voltage raceway to the Personality board.

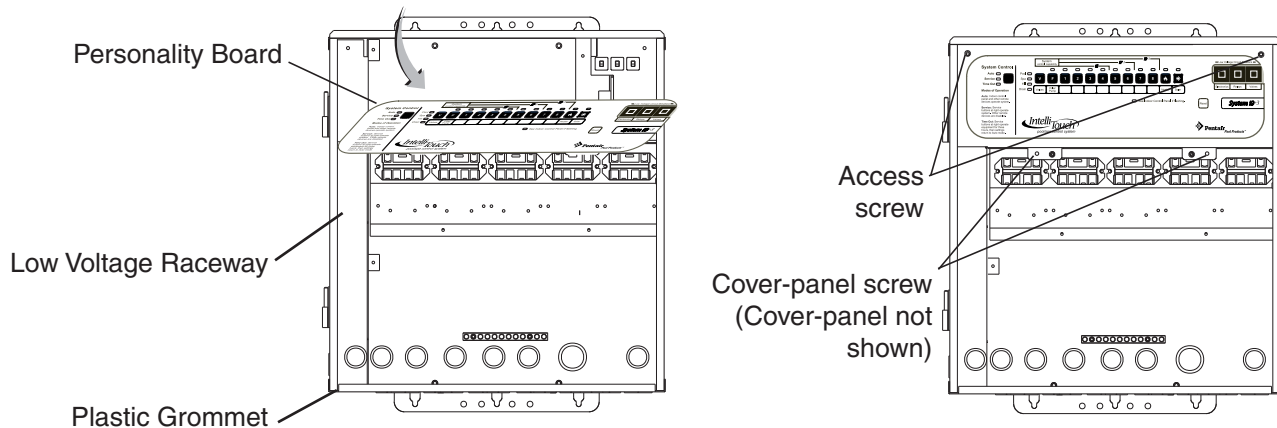

IntelliTouch Control System Load Center

Connecting IntelliFlo® Pump to IntelliTouch® Control System (Continued)

- Strip back the cable conductors ¼". Insert the wires into the either of the **COM PORTS (J7 and J8)** screw terminals located on the left side of the Personality board. Secure the wires with the screws. For wiring details, refer to the pin configuration shown below.

Note: Multiple wires may be inserted into a single screw terminal.

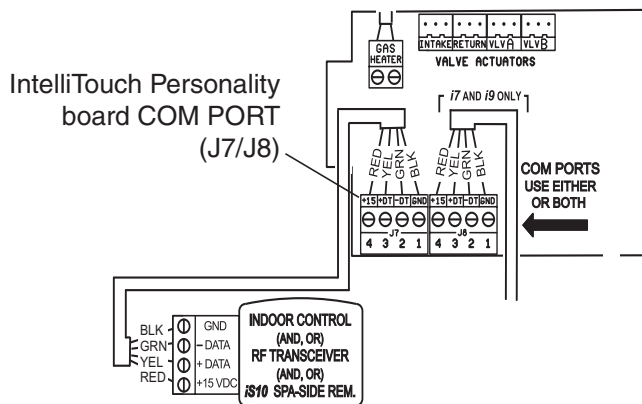

Pin Configuration for IntelliFlo Pump to IntelliTouch Control System:

- IntelliFlo: Connect pin 6 (green) to IntelliTouch control system screw terminal pin 2 (green)
- IntelliFlo: Connect pin 7 (yellow) to IntelliTouch control system screw terminal pin 3 (yellow)

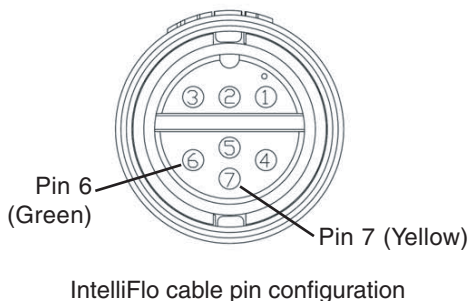

IntelliTouch
COM PORT (J7/J8)
screw terminal

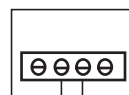

IntelliTouch screw terminal connector	IntelliFlo (2-wire cable)
2 (GRN)	GREEN (Pin 6)
3 (YEL)	YELLOW (Pin 7)

Pin configuration

- Close the control system control panel and secure it with the two access screws.
- Install the high voltage panel cover and secure it with the two retaining screws.
- Close the load center front door and secure with the two latches.
- Switch power on to the IntelliTouch control system load center.

Backwash Mode

When the Filter mode has detected that the differential pressure is at the “Clean Filter Pressure” the filter must be cleaned. You need to stop the IntelliFlo® VF Variable Flow Pump either by pressing the Backwash button or “Start/Stop” button. The pump must now be run for a preset cycle time with a preset flow. The flow is adjustable to accommodate the specific filter backwash flow requirement. After the backwash cycle, a rinse cycle, with preset duration time will be executed. When the two cycles have been completed or if the Start/Stop button is pressed to stop the process, the filter status will be recalculated and the zero-pressure measured when Filter mode is operated again.

- Backwash is an essential mode for cleaning as well as maintaining the % Clean Filter menu
- Backwash mode tells the computer to recalculate the clean filter pressure and start a new cycle
- Backwash button doubles for Rinse in operation
- When using cartridge filters the backwash cycle must be performed when cleaning or replacing filters. This helps the computer reset its 0 head pressure level
- If you are charging a DE system, charge the system first during a normal running cycle. After the filter is charged, run the pump in backwash mode with the filter valve in the filter position to reset the % clean filter status. Then run the pump in filter mode.

Note: The pump will ramp up to full speed if necessary to achieve the commanded flow. Be sure that the system can withstand the resultant pressures.

Backwash Menu

To access the Backwash menu:

1. Ensure that the green power LED is on and the pump is stopped.
2. Press the **Menu** button. Press the **Up** or **Down** arrows to select the “Backwash” menu.
3. **To set the backwash flow parameter:** Press the **Select** button, the “Backwash Flow” parameter is displayed. To edit the backwash flow parameter, see step 6.

This parameter can be set from 15 GPM to 130 GPM. The default setting is 60 GPM. This parameter sets the preset flow for both backwash and rinse modes.

4. **To set the backwash cycle time parameter:** Press the **Up** or **Down** arrows to select the “Backwash Duration” menu. To edit this setting, see step 6.

This parameter can be set from 1 to 60 minutes. The default setting is 5 minutes. This setting is the cycle time for the backwash mode.

5. **To set the backwash rinse time parameter:** Press the **Up** or **Down** arrows to select the “Rinse Duration” menu. To edit this setting, see step 6.

This parameter can be set from 1 to 60 minutes. The default setting is 1 minutes. This setting is the cycle time for the rinse mode.

6. To change the value, press the **Left** and **Right** arrows to select which digit to modify, then use the **Up** and **Down** arrows to change the selected digit.
7. When you are done, press the **Enter** button to save the changes. To cancel any changes, press the **Escape** button to exit edit mode without saving.

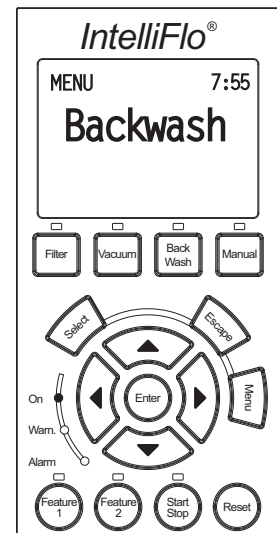

Running Backwash Mode

To start Backwash mode:

1. Press the **Backwash** button.
2. When running in Backwash mode the IntelliFlo® VF Variable Flow Pump will run at the preset backwash flow for the preset backwash time.
3. When the Backwash mode is stopped, manually or after the preset Backwash cycle time, the pump will stop and show the “Rinse” menu option.
4. Press the **Start/Stop** button after repositioning the backwash valve to rinse the filter.
5. When running in Rinse mode, the pump will run at the preset backwash flow for the preset rinse time.
6. Once the pump has run in both Backwash and Rinse modes, the filter status will be recalculated in filter mode.
7. After completing Backwash and Rinse, the backwash valve should be placed into the filter position, unless other service is required.

Backwash menu screens

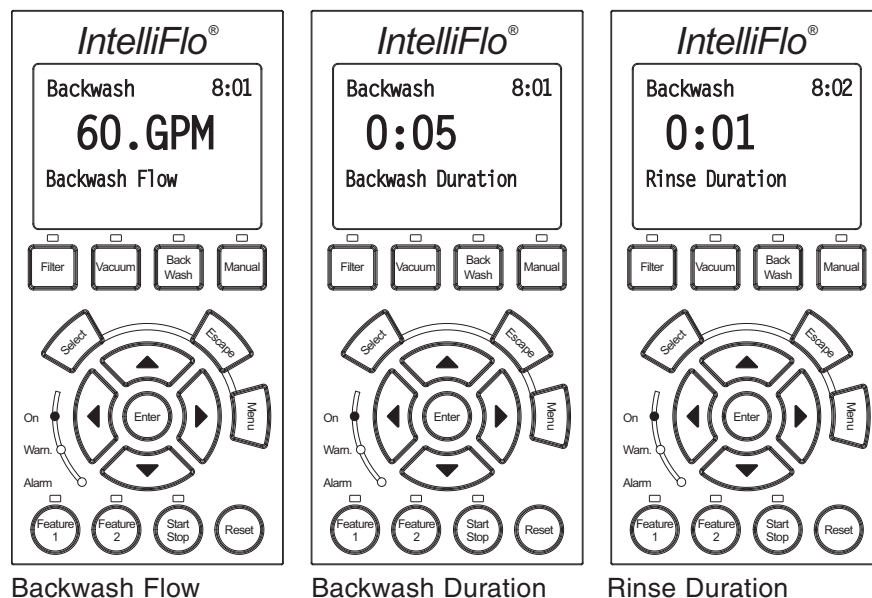

Vacuum Mode

Use Vacuum mode to clean the pool manually. Vacuum mode only operates in flow control. Vacuum mode shuts off all sensors. This mode is identical to Feature 1 and 2 except that you can manually start this mode using the Vacuum button. Safety considerations should be made when setting the Vacuum flow parameter.



Since vacuuming is manual work and the user will be at the pool, the “Blocked System” will be switched off, it is important not to use any kind of automatic cleaners with vacuum mode.

Vacuum menu

To access the Vacuum menu:

1. Ensure that the green power LED is on and the IntelliFlo® VF Variable Flow Pump is stopped.
2. Press the **Menu** button. Press the **Up** or **Down** arrows to select the “Vacuum” menu.
3. **To set the vacuum flow parameter:** Press the **Select** button, the “Vacuum Flow” parameter is displayed. To edit the vacuum preset flow parameter, see step 5.

This parameter can be set from 15 GPM to 130 GPM. The default setting is 50 GPM.

4. **To set the vacuum duration parameter:** Press the **Up** or **Down** arrows to select the “Vacuum Duration” menu. To edit this setting, see step 5.

This parameter can be set from 1 to 600 minutes. The default setting is 10 minutes. This setting is the amount of time you wish to run vacuum mode.

5. To change the value, press the **Left** and **Right** arrows to select which digit to modify, then use the **Up** and **Down** arrows to change the selected digit.
6. When you are done, press the **Enter** button to save the changes. To cancel any changes, press the **Escape** button to exit edit mode without saving.

To start Vacuum mode:

1. Press the **Vacuum** button to start the vacuum mode and to run at the preset vacuum flow for the preset vacuum cycle time.
2. After the preset cycle time, the pump will stop.

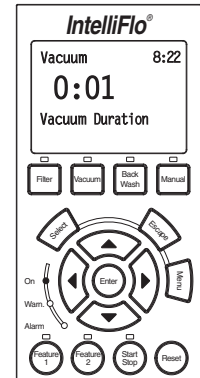
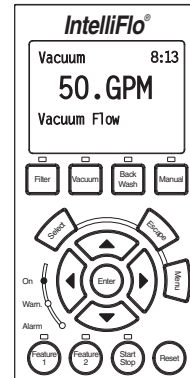
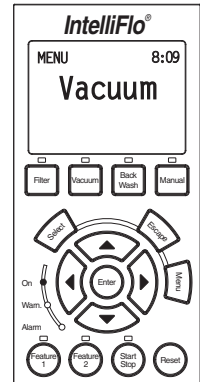

Vacuum Flow and Duration

MAINTENANCE

The following information describes how to service and maintain the IntelliFlo® VF Variable Flow Pump.

Pump Strainer Basket

The strainer, sometimes referred to as the “Hair and Lint Pot,” is in front of the of the pump. Inside there is a basket which must be kept clean of leaves and debris at all times. View the basket through the top see through lid to inspect for leaves and debris.

Regardless of the length of time between filter cleaning, it is most important to visually inspect the hair and lint pot basket at least once a week. A dirty basket will reduce the efficiency of the filter and possibly the heater.

⚠ WARNING **DO NOT** open the strainer pot if pump fails to prime or if pump has been operating without water in the strainer pot. Pumps operated in these circumstances may experience a build up of vapor pressure and may contain scalding hot water. Opening the pump may cause serious personal injury. In order to avoid the possibility of personal injury, make sure the suction and discharge valves are open and that the strainer pot is cool to the touch, then open with extreme caution.

⚠ CAUTION To prevent damage to the pump and filter and for proper operation of the system, clean pump strainer and skimmer baskets regularly.

Pump Strainer Basket Service

If the pump is installed below the water level of the pool, close the return and suction lines before opening the hair and lint pot on the pump.

1. Place the pump in “Manual” mode. Press the Start/Stop button to stop the pump and switch off the pump at the circuit breaker.
2. Disconnect the communication cable from the pump.
3. Relieve pressure in the system.
4. Turn the clamp and lid in a counterclockwise direction until it stops.
5. Remove the clamp and lid.
6. Remove the basket and put the debris into the trash and rinse out the basket. If the basket is cracked, replace the basket.
7. Replace the basket and fill the pump pot and volute with water up to the inlet port.
8. Clean the cover, O-ring, and sealing surface of the pump pot. Grease the O-ring with silicone lubricant.
9. Reinstall the lid by placing the clamp and the lid on the pot.
10. Ensure that the lid o-ring is properly placed. Seat the clamp and lid then turn clockwise until the handles are horizontal as shown.

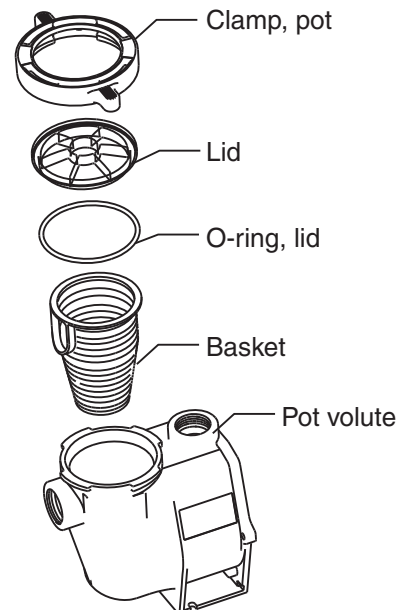

Pump Strainer Basket Service (Continued)

11. Reconnect the communication cable to the IntelliFlo® VF Variable Flow Pump if required.
12. Switch the power ON at the circuit breaker. Reset the pool time clock to the correct time.



WARNING FILTER OPERATES UNDER HIGH PRESSURE. WHEN ANY PART OF THE CIRCULATING SYSTEM (e.g., LOCK RING, PUMP, FILTER, VALVES, ETC.) IS SERVICED, AIR CAN ENTER THE SYSTEM AND BECOME PRESSURIZED. PRESSURIZED AIR CAN CAUSE THE LID TO SEPARATE WHICH CAN RESULT IN SEVERE INJURY, DEATH, OR PROPERTY DAMAGE. TO AVOID THIS POTENTIAL HAZARD, FOLLOW THESE INSTRUCTIONS.

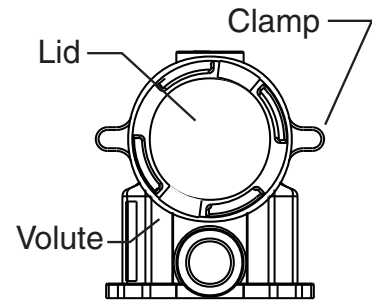

13. Open the manual air relief valve on top of the filter.
14. Stand clear of the filter. Press the Start button on the pump.
15. Bleed air from the filter until a steady stream of water comes out.
16. Close the manual air relief valve.

Motor Service

1. **Protect from heat:**
 - Shade the motor and controller from the sun.
 - Any enclosure must be well ventilated to prevent overheating. Particular attention should be paid to the motor fan cover and the cooling fins between the drive and the motor.
 - Provide ample cross ventilation.
2. **Protect against dirt:**
 - Protect from any foreign matter.
 - Do not store (or spill) pool chemicals near the motor.
 - Avoid sweeping or stirring up dust near the motor while it is operating.
 - If a motor has been damaged by dirt it may void the motor warranty.
3. **Protect against moisture:**
 - Protect from continuous splashing or continuous sprayed water.
 - Protect from extreme weather such as flooding.
 - Protect from lawn sprinklers.
 - If motor internals have become wet - let it dry before operating. Do not allow the pump to operate if it has been flooded.
 - If a motor has been damaged by water it may void the motor warranty.

Note: DO NOT wrap motor and controller with plastic or other air tight materials. The motor and controller may be covered, but not wrapped in plastic, during a storm, for winter storage, etc., but never when operating, or expecting operation.

When replacing the motor, be certain that the motor support is correctly positioned to support the size of motor being installed.

Winterizing

The IntelliFlo® VF Variable Flow Pump's internal anti-freeze protection is disabled when connected to an IntelliTouch® Control System. Freeze protection is provided by selecting YES at the ON WITH FREEZE portion of the control system's appropriate circuit function menu. To re-enable the pump's internal anti-freeze protection, the power to the drive must be cycled off then back on.

1. If the air temperature drops below 35° F the water in the pump can freeze and cause damage. Freeze damage is not warrantable.
2. To prevent freeze damage follow the procedures listed below.
 - Shut off electrical power for the pump at the circuit breaker.
 - Drain the water out of the pump by removing the two thumb-twist drain plugs located at the bottom of the volute. Store the plugs in the pump basket.
 - Cover the motor to protect it from severe rain, snow and ice.
 - Do not wrap the motor in plastic. It will cause condensation and rust on the inside of the motor.

Note: In mild climate areas, when temporary freezing conditions may occur, run your filtering equipment all night to prevent freezing.

Manual Priming and Initial Start-up After Service

Before a system start-up, the pump and system must be manually primed. Make sure to reopen valves before operating. To prime the pump, the strainer pot must be filled with water.

CAUTION DO NOT run the pump dry. If the pump is run dry, the mechanical seal will be damaged and the pump will start leaking. If this occurs, the damaged seal must be replaced. ALWAYS maintain proper water level in your pool. Continued operation in this manner could cause a loss of pressure, resulting in damage to the pump case, impeller and seal.

To prime the pump:

1. Turn the pump clamp and lid in a counterclockwise direction until it stops and remove them.
2. Fill the pump strainer pot with water.
3. Reinstall the pump clamp and lid onto the strainer pot.
The pump is now ready to prime.
4. Make sure all electrical connections are clean and tight.
5. Open the air release valve on the filter, and stand clear of the filter.
6. Switch the pump on at the circuit breaker. Ensure that the green power LED is on.
7. Press the **Manual** button (LED on) to place the pump in manual mode.
8. Use the **Up** and **Down** arrows to select **Set Speed**, then press the **Select** button to edit the setting.
7. Adjust speed as necessary. Press the **Left** and **Right** arrows to select which digit to modify, then use the **Up** and **Down** arrows to change the speed. Press the **Enter** button to save the changes. To cancel any changes, press the **Escape** button to exit edit mode without saving.
9. Press the **Start/Stop** button to start the pump.
10. When water comes out of the air release valve, close the valve. The system should now be circulating water back to the pool without air bubbles showing in either the hair and lint pot or at the pool return fittings.

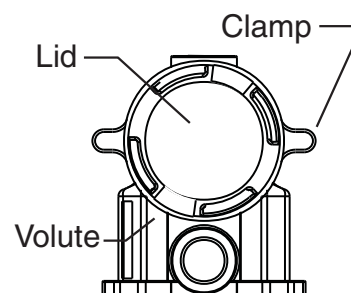

INSTALLATION AND REMOVAL

The following general information describes how to install the IntelliFlo® VF Variable Flow Pump

Attention Installer: Before installing the pump, read and follow all warning notices, instructions and safety precautions on pages ii - iii.

Installing the IntelliFlo VF Pump

Only a qualified service person should install the pump.

Location

CAUTION



Install all electrical controls at equipment pad, such as on/off switches, timers, and control systems, etc. to allow the operation (start-up, shut-down, or servicing) of any pump or filter so the user does not place any portion of his/her body over or near the pump strainer lid, filter lid or valve closures. This installation should allow the user enough space to stand clear of the filter and pump during system start-up, shut-down or servicing of the system filter. Refer to warnings and safety instructions on page ii - iii.

1. Install the pump as close to the pool or spa as possible. To reduce friction loss and improve efficiency, use short and direct suction and piping returns.
2. Install a minimum of 5 feet (1.52 meters) from the inside wall of the pool and spa. Canadian installations require a minimum of 9.8 feet (3 meters) from pool water.
3. Install the pump a minimum of 2 feet (0.61 meters) from the heater inlet.
4. Do not install the pump more than 8 feet (2.44 meters) above the water level.
5. Install the pump in a sheltered well ventilated location protected from excessive moisture, (i.e., rain, sprinklers, etc.).
6. For hot tubs and spas, do not install within an outer enclosure or beneath the skirt of a hot tub or spa.
7. Install the pump with a rear clearance of at least 6 inches (15.2 cm) so that the motor can be removed easily for maintenance and repair.

Piping

For most installations Pentair recommends installing a valve on both the pump suction and return lines so that the pump can be isolated during routine maintenance. We also recommend a valve, elbow or tee installed in the suction line should be no closer to the front of the pump than five (5) times the suction line pipe diameter.

Example: A 2 inch pipe requires a 10 inch (254 mm) straight run in front of the suction inlet of the pump). This will help the pump prime faster and last longer.

Note: DO NOT install 90° elbows directly into the pump inlet and outlet.

Check Valves

Check valves must be used when an IntelliFlo pump is used in parallel with other pumps. IntelliFlo pumps cannot be connected in series with other pumps.

Wiring the IntelliFlo® VF Pump

To connect the IntelliFlo pump to AC power:

1. Make sure all electrical breakers and switches are turned off before wiring motor.
2. Make sure that the wiring voltage is 230 VAC.
3. Use #12 AWG for wire runs up to 100 feet (30.48 meters) and #10 AWG for lengths longer than 100 feet (30.48 meters). When in doubt use a heavier gauge (larger diameter) wire. Heavier gauge will allow the motor to run cooler and more efficient.
4. Make sure all electrical connections are clean and tight.
5. Cut the wires to the appropriate length so they do not overlap or touch when connected.
6. Permanently ground the motor using the green ground wire, as shown below. Use the correct wire size and type specified by National Electrical Code. Make sure the ground wire is connected to an electrical service ground.
7. Bond the motor to the pool structure in accordance with the National Electrical Code. Use a solid No. 8 AWG or larger copper conductor (No. 6 or larger in Canada). Run a wire from the external bonding lug to the pool bonding structure, as shown below.
8. The pump should be permanently connected to either a **circuit breaker, 2-pole timer** or **2-pole relay**. If AC power is supplied by a GFCI circuit breaker, use a dedicated circuit breaker that has no other electrical loads.
9. **IMPORTANT: When connecting the pump to an automation system (IntelliTouch®, EasyTouch®, SunTouch® Control Systems and IntelliComm® Communication Center), continuous power must be supplied to the pump by connecting it directly to the circuit breaker. When using an automation system, Be sure that no other lights or appliances are on the same circuit.**

NOTE: When the pump is started and stopped by removing power with a relay or timer, a two-pole device should be used to apply and remove power to both POWER LINE TERMINALS.

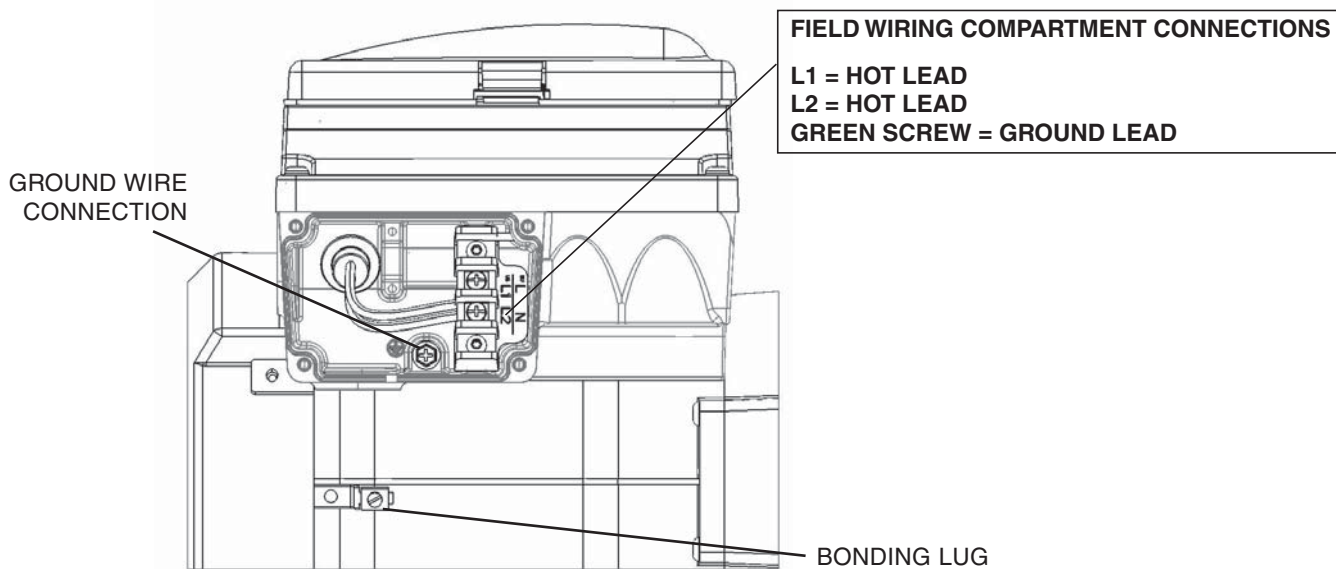

Pump Disassembly

⚠ WARNING



Always disconnect power to the IntelliFlo® VF Variable Flow Pump at the circuit breaker before servicing the pump. Failure to do so could result in death or serious injury to serviceman, pool users or others due to electric shock.

Read all servicing instructions before working on the pump.

⚠ WARNING

DO NOT open the strainer pot if pump fails to prime or if pump has been operating without water in the strainer pot. Pumps operated in these circumstances may experience a build up of vapor pressure and may contain scalding hot water. Opening the pump may cause serious personal injury. In order to avoid the possibility of personal injury, make sure the suction and discharge valves are open and strainer pot temperature is cool to touch, then open with extreme caution.

⚠ CAUTION

Be sure not to scratch or mar the polished shaft seal faces; seal will leak if faces are damaged.

All moving parts are located in the rear sub-assembly of the pump.

Tools required:

- 3/32 inch Allen head wrench.
- ½ inch open end wrench.
- 9/16 inch open end wrench.
- Flat blade screwdriver.

To remove and repair the pump mechanical seal, perform the following procedures:

1. Switch off the pump circuit breaker at the main panel.
2. Disconnect the communication cable from the pump.
3. Drain the pump by removing the drain plugs.
4. Remove the six bolts that hold the main pump body (strainer pot/volute) to the rear sub-assembly.
5. GENTLY pull the two pump halves apart, removing the rear sub-assembly.
6. Use a 3/32 inch Allen head wrench to loosen the two holding screws located on the diffuser.
7. Hold the impeller securely in place and remove the impeller lock screw by using a Phillips head screwdriver. The screw is a left-handed thread and loosens in a clockwise direction.
8. Use a flat blade screwdriver to hold the motor shaft. The motor shaft has a slot on the end which is accessible through the center of the fan cover.

Pump Disassembly (Continued)

9. To unscrew the impeller from the shaft, twist the impeller counterclockwise.
10. Remove the rotating portion of the mechanical seal from the impeller.
11. Remove the four bolts from the seal plate to the motor, using a 9/16 inch wrench.
12. Place the seal plate face down on a flat surface and tap out the carbon spring seat.
13. Clean the seal plate, seal housing, and the motor shaft.

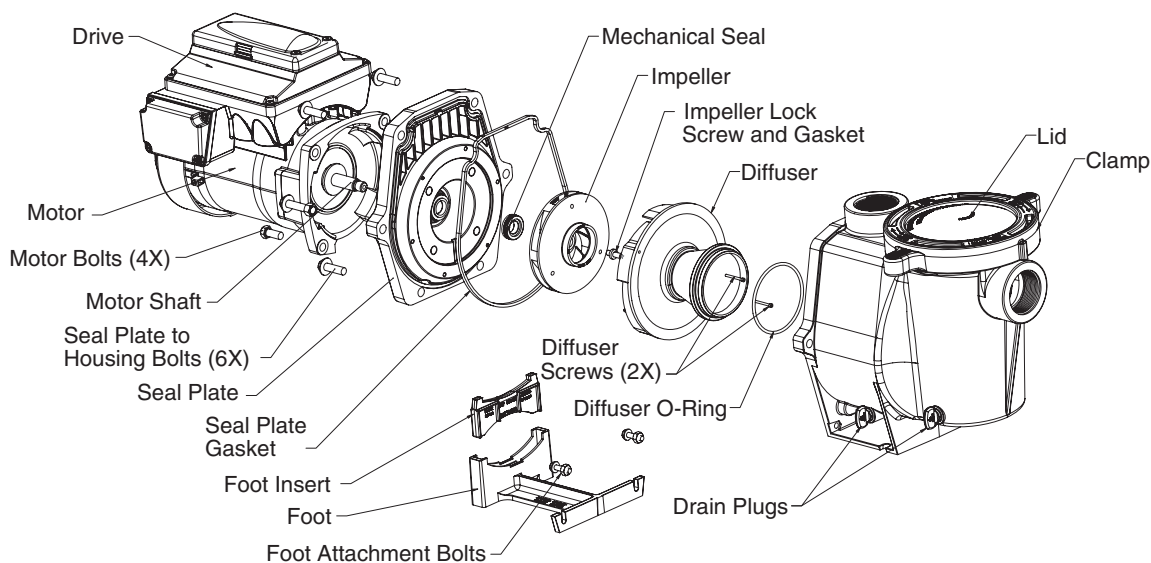

Pump Reassembly/Seal Replacement

1. When installing the replacement shaft seal, use silicone sealant on the metal portion before pressing into the seal plate as shown above.
2. Before installing the rotating portion of the seal into the impeller, be sure the impeller is clean. Use a light density soap and water to lubricate the inside of the seal. Press the seal into the impeller with your thumbs and wipe off the ceramic and carbon faces with a clean cloth.
3. Remount the seal plate to the motor.
4. Grease the motor shaft thread and screw impeller onto the motor shaft.
5. Screw in the impeller lock screw (counterclockwise to tighten).
6. Remount the diffuser onto the seal plate. Make sure the plastic pins and holding screw inserts are aligned.
7. Grease the diffuser O-ring and seal plate gasket prior to reassembly.
8. Grease the bolt threads, assemble the motor sub-assembly to the strainer pot-pump body by using the two (2) through bolts for proper alignment. Do not tighten the through bolts until all six (6) bolts are in place and finger tightened.
9. Fill the IntelliFlo® VF Variable Flow Pump with water.
10. Reinstall the pump lid and plastic clamp then re-prime the system, see page 37.

Drive Assembly Removal and Installation

To remove the IntelliFlo® VF Variable Flow Pump drive and control panel from the motor assembly:

1. Make sure all electrical breakers and switches are turned off before removing the drive.
2. Disconnect the communication cable from the IntelliFlo pump.
3. Open the control panel cover.
4. Remove the three Phillips head screws securing the drive to the motor assembly as shown.

CAUTION TO AVOID ELECTRICAL HAZARD, DO NOT REMOVE THE TAMPER PROOF SCREWS (QTY 4) FROM THE MOTOR ASSEMBLY.

5. Lift up the drive assembly and remove it from the motor adapter located on top of the motor assembly.

Note: Be careful not to remove the gasket between the drive and motor, it is critical in keeping moisture out of the drive and motor. Replace the gasket if damaged. Do not reassemble with a damaged or missing gasket.

To install the pump drive assembly onto the motor assembly:

1. Make sure all electrical breakers and switches are turned off before removing the drive.
2. Ensure that the gasket between the drive and motor is in place. It is critical in keeping moisture out of the drive and motor. Replace the gasket if damaged. Do not reassemble with a damaged or missing gasket.
3. Align the drive assembly with the motor adapter and seat the drive on the motor assembly.
4. Secure and tighten the drive assembly with the three Phillips head screws.

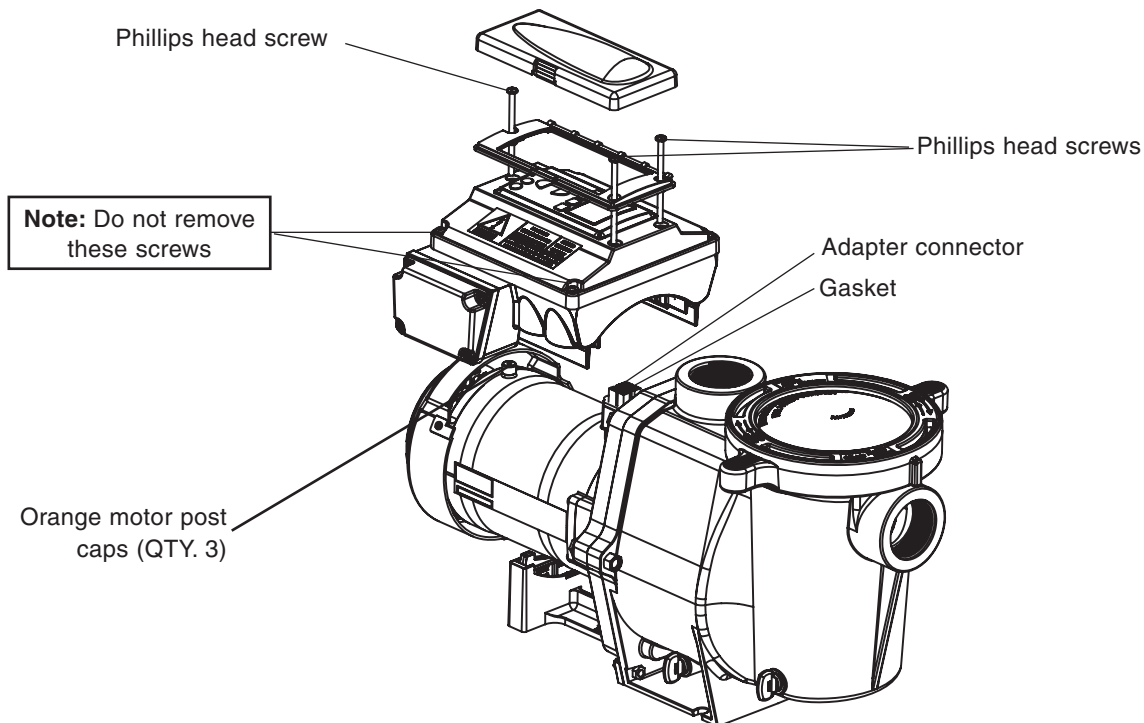

Illustrated Parts List

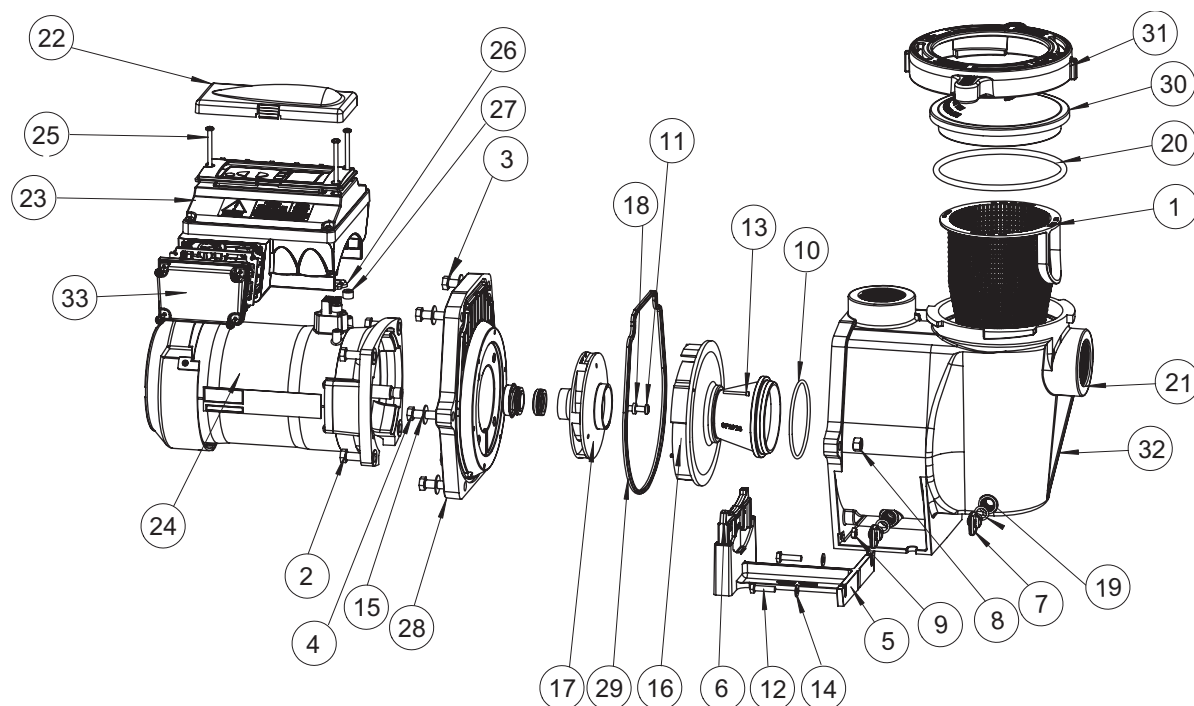

Replacement Parts

Item No.	Part No.	Description	Item No.	Part No.	Description
1	070387	BASKET AQ & WF	16	072928	DIFFUSER ASSEMBLY WFE 12
2	070429	BOLT HEX HD, 2-56x0.875 s/s, (QTY 4)	17	073131	IMPELLER WFE 12 1000 SER
3	070430	BOLT 3/8 - 16 X 1 1/4 HEX CAP 18-8 s/s, (QTY 4)	18	075713	RUBBER WASHER WFE PUMP
4	070431	BOLT 3/8 - 16 X 2 HEX CAP 18-8 s/s, (QTY 2)	19	192115	O-RING 112, 0.487x0.103 Buna-N 70 (QTY 2)
5	070927	FOOT WF - PUMP MOTOR SUPPORT	20	350013	O-RING LID CH/WF 2-436
6	070929	FOOT INSERT WF PUMP	21	350015	HOUSING WFE (Almond)
7	071131	PLUG DRAIN WFE (Almond) (QTY 2)	22*	400100	CONTROL COVER ASSEMBLY
8	071403	NUT 3/8 - 16 BRASS NICKEL PLATED, (QTY 2)	23**	350721	INTELLIFLO VAR-SPD MTR DRV 3.2KW
9	071406	NUT 1/4 - 20 HEX s/s (QTY 2)	24**	350105S	VFD MOTOR 3.2 KW PMSM
10	355227	O-RING 238, 3.484x0.139, Buna-N 70	25	350107	SCREW 10-24 X 3/4 in. PH MS 18-8 s/s, (QTY 3)
11	071652	SCREW 1/4-20 X 1 LH PHILLIPS PAN MS 18-8 s/s	26	350108	INTELLIFLO DRIVE GASKET
12	071657	SCREW 1/4 - 20 X 1 in. HEX CAP 18-8 s/s, (QTY 3)	27	350142	SPACER CAP (QTY 3)
13	071660	SCREW SET 4-40 X 1-1/8 WFE SCKT CAP 18-8 s/s (QTY 2)	28	350202	SEAL PLATE KIT, WFE ALMOND
14	072183	WASHER FLAT 1/4 X 5/8 20 GA THICK 18-8 s/s (QTY 2)	29	357100	GASKET SANTOPRENE MOLDED
15	072184	WASHER 3/8 ID X 7/8 OD .05 THICK 18-8 s/s, (QTY 6)	30	357151	LID SEE THRU WF
			31	357199	CLAMP CAM & RAMP WF (Almond)
			32	357243	POT WF ASSY (Almond)
			33	350621	COVER ASSEMBLY, FWC

(*) PRIOR TO MID SUMMER 2011 USE 350082 CONTROL COVER ASSEMBLY. P/N ON INSIDE COVER.

(**) NOT SERVICEABLE PARTS

IntelliFlo® VF Pump Dimensions

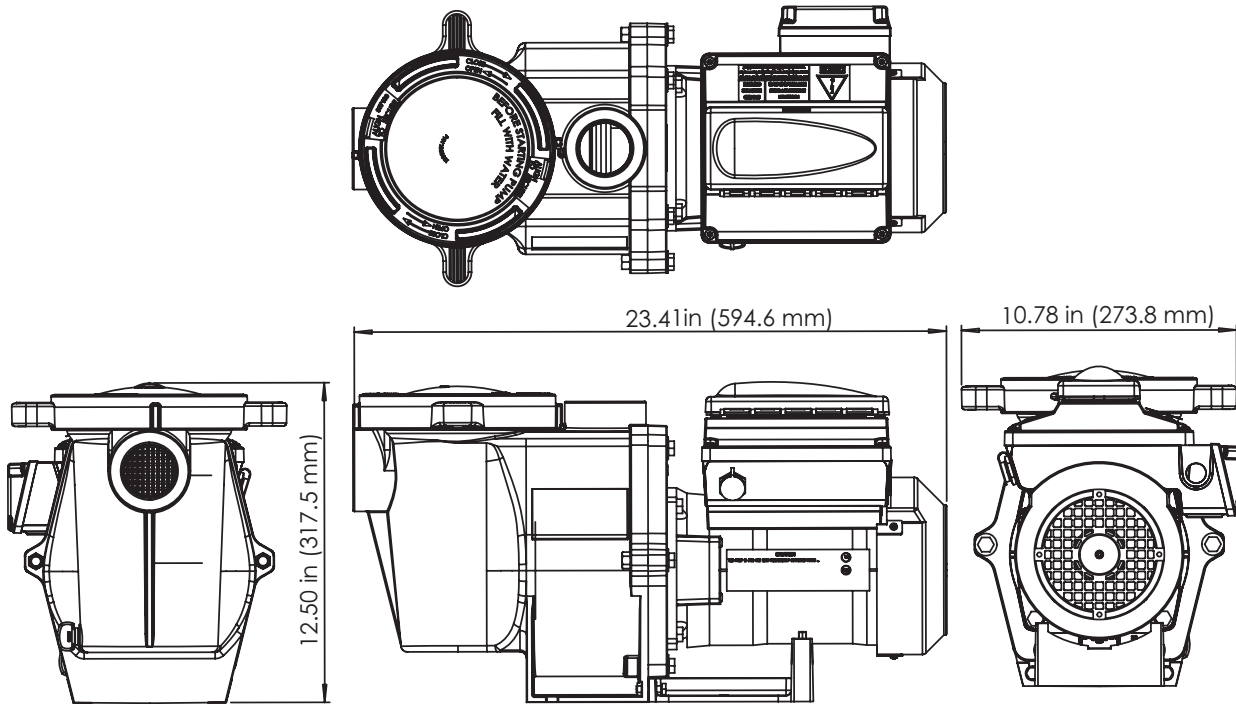

IntelliFlo VF Flow and Power vs Flow Pump Curve

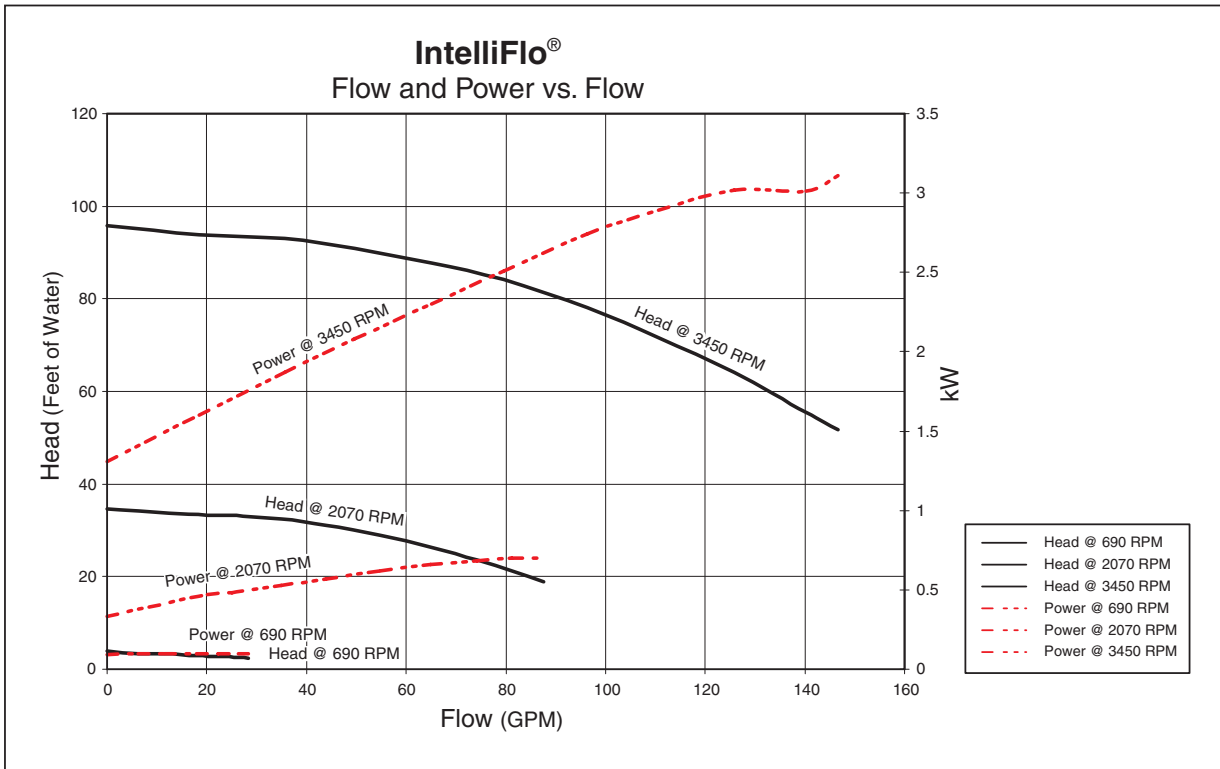

IntelliFlo VF Electrical Specifications

Circuit Protection: Two-pole 20 AMP device at the Electrical Panel.

Input: 230 VAC, 50/60 Hz, 3200 Watts

TROUBLESHOOTING

IMPORTANT: Before troubleshooting the pump, read and follow all warning notices, instructions and safety precautions on pages ii - iii.

Alerts and Warnings

The IntelliFlo® VF Variable Flow Pump displays all alarms and warnings on the control panel display. When an alarm or warning condition exists, the corresponding LED will be lit on the display. All control panel buttons are disabled until the alarm or warning is acknowledged with the **Enter** button. Press the **Reset** button to clear the alarm once the fault condition has been resolved.

Note: The pump will not start if the impeller is rotating. The alerts and warnings are:

- **Power out failure:** The incoming supply voltage is less than 170 VAC. The drive faults to protect itself from over current. The drive contains capacitors that keep it powered up long enough to save the current run parameters.
- **Priming error:** If the pump is not defined as primed within the “Max Priming Time” it will stop and generate a “Priming Alarm” for 10 minutes, then attempt to prime again. The “Max Priming Time” is set by the user on the priming menu as discussed on page 14. If the pump cannot prime within five attempts it will generate a permanent alarm that must be manually reset.
- **Overheat alert:** If the drive temperature gets above 130 degrees, the pump will slowly reduce speed until the over temperature condition clears.
- **Anti-freezing:** When active, the motor will run at 1000 rpm for 60 minutes. Only active in Filter and Manual modes.

Note: The pump’s internal anti-freeze protection is disabled when connected to an IntelliTouch® Control System. Freeze protection is provided by selecting YES at the ON WITH FREEZE portion of the IntelliTouch control system’s appropriate circuit function menu. To re-enable the pump’s internal anti-freeze protection, the power to the drive must be cycled off then back on.

- **Blocked system:** Detects a blocked suction line. This alarm resets automatically after 30 seconds and the pump restarts.
- **System service soon:** Alerts the operator that the pump discharge pressure has reached the Clean Filter Pressure as setup in the Filter Menu. The filter status will be displayed as 100%. The yellow warning LED will be on until a backwash cycle is operated. The pump will automatically reduce speed as necessary to not exceed the Clean Filter Pressure.
- **Over current:** Indicated that the drive is overloaded or the motor has an electrical problem. The drive will restart 20 seconds after the over current condition clears.
- **Over voltage:** Indicates excessive supply voltage or an external water source is causing the pump and motor to rotate thereby generating an excessive voltage on the drives internal DC bus. The drive will restart 20 seconds after the over voltage condition clears.

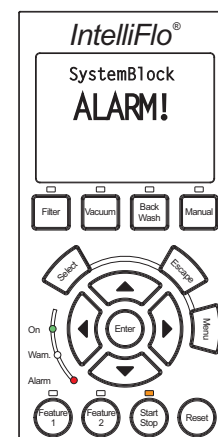

Suction Blockage

When something blocks the suction or the pump fully it will shut off immediately (within 1 second). It will also shut off after a few seconds of dead heading with the same alert. The unit will come back on in 30 seconds and ramp up slowly. This function should be tested with all new installations by directing the flow to one suction and covering it with a piece of material other than someone’s hand. This alert is deactivated in Manual mode.

General Troubleshooting Problems

Use the following general troubleshooting information to resolve possible problems with your IntelliFlo® VF Variable Flow Pump.

Note: Turn off power to unit prior to attempting service or repair.

Problem	Possible Cause	Corrective Action
<p>Pump Failure.</p> <p>(For alert display messages, refer to Alerts and Warnings on page 45).</p>	<p>Pump will not prime - Air leak in suction.</p> <p>Pump will not prime - Not enough water.</p> <p>Pump strainer clogged.</p> <p>Pump strainer gasket defective.</p>	<p>Check suction piping and valve glands on any suction gate valves.</p> <p>Secure lid on pump strainer pot and make sure lid gasket is in place.</p> <p>Check water level to make sure skimmer is not drawing air.</p> <p>Ensure that the suction lines, pump, strainer, and pump volute are full of water.</p> <p>Clean pump strainer pot.</p> <p>Replace gasket.</p>
<p>Reduced Capacity and/or Head.</p> <p>(For alert display messages, refer to Alerts and Warnings on page 45).</p>	<p>Air pockets or leaks in suction line.</p> <p>Clogged impeller.</p> <p>Pump strainer clogged.</p>	<p>Check suction piping and valve glands on any suction gate valves.</p> <p>Turn off electrical power to the pump.</p> <p>Remove the (6) bolts that holds the volute to the seal plate.</p> <p>Slide the motor and seal plate away from the volute.</p> <p>Clean debris from impeller. If debris cannot be removed, complete the following steps.</p> <ol style="list-style-type: none"> 1. Remove diffuser and O-ring. 2. Remove left hand thread anti-spin bolt and O-ring. 3. Remove, clean and reinstall impeller. 4. Reinstall anti-spin bolt and O-ring. <p>Reinstall motor and seal plate into volute.</p> <p>Reinstall (6) bolts around seal plate and volute and tighten securely.</p> <p>Clean suction trap.</p>
<p>Inadequate Circulation.</p> <p>(For alert display messages, refer to Alerts and Warnings on page 45).</p>	<p>Pump overcurrent.</p>	<p>Check trap basket; if plugged, turn pump off and clean basket.</p> <p>Suction/discharge piping is too small.</p> <p>Check and clean pool filter.</p>
<p>Circuit Breaker Trips Repeatedly.</p> <p>(For alert display messages, refer to Alerts and Warnings on page 45).</p>	<p>Excessive motor current.</p> <p>GFCI fault.</p>	<p>Breaker must be of adequate capacity. For GFCI breaker, test according to GFCI manufacturer's instructions. Be sure no other lights and appliances are on circuit.</p> <p>Voltage too high or too low.</p>

General Troubleshooting Problems (Continued)

Problem	Possible Cause	Corrective Action
<p>Electrical Problem.</p> <p>(For alert display messages, refer to Alerts and Warnings on page 45).</p>	<p>Pump may be running too slowly.</p> <p>Pump may be too hot.</p>	<p>Check voltage at motor terminals and at meter while pump is running. If low, see wiring instructions or consult power company.</p> <p>Check for loose connections.</p> <p>Check line voltage; if less than 90% or more than 100% of rated voltage consult a licensed electrician.</p> <p>Increased ventilation.</p> <p>Reduce ambient temperature.</p> <p>Tighten any loose wiring connections.</p> <p>Motor internal terminal overload protector is open.</p> <p>Motor runs too hot.</p> <p>Turn power to motor off.</p> <p>Check for proper voltage.</p> <p>Check for proper impeller or impeller rubbing.</p>
<p>Mechanical Troubles and Noise</p>	<p>The pump motor is running but with loud noise.</p> <p>Cavitation.</p>	<p>If suction and discharge piping are not adequately supported, pump assembly will be strained. Do not mount pump on a wooden platform! Securely mount on concrete platform for quietest performance.</p> <p>Foreign matter (gravel, metal, etc.) in pump impeller.</p> <p>Disassemble pump, clean impeller, follow pump service instructions for reassembly.</p> <p>Improve suction conditions.</p> <p>Increase pipe size.</p> <p>Decrease number of fittings.</p> <p>Increase discharge pressure.</p>
<p>Pump does not respond to IntelliTouch commands.</p>	<p>Improper IntelliTouch/IntelliFlo setup.</p> <p>Communication network inoperative.</p>	<ol style="list-style-type: none"> 1. Ensure that the communication cable is connected at both ends. 2. Check that the IntelliFlo local address matches with the address used in the IntelliTouch. 3. Check that the IntelliFlo has been assigned a circuit name on the IntelliTouch. 4. Ensure that the IntelliFlo display says "DISPLAY NOT ACTIVE". <p>A defective device on the network can inhibit the proper operation of another network device. Devices should be disconnected sequentially until the network starts working.</p>

General Warnings

- Never go inside the drive enclosure. There is a capacitor bank that holds a 230 VAC charge even when there is no power to the unit.
- The IntelliFlo® VF Variable Flow Pump is not submersible.
- The pump is capable of 160 GPM or 104 feet (31.7 meters) of head; use caution when installing and programming to limit pumps performance potential with old or questionable equipment.
- Code requirements for the electrical connection differ from state to state. Install equipment in accordance with the National Electrical Code and all applicable local codes and ordinances.
- There is no pressure limit in “Features” flow control.
- Manual mode shuts off all sensors including Suction Blockage; use only in an emergency or when metering a system.
- The unit needs constant power. It is built to turn itself on / off.
- Always stop the unit before performing maintenance.

Electrical Cost Overview

To calculate a system’s “Continuous Watts” use the following formula:

Amps X Volts X Power Factor = Continuous Watts

Examples:

- 1 HP E+ WhisperFlo = 7.4 amps X (230 Volt) X .90 PF = 1532 watts
- 1 HP Max – E – Pro = 8.0 amps X (230 Volt) X .87 PF = 1600 watts

Once watts are computed, convert watts to kilowatts (kilo is 1000) and multiply this number by kilowatt/hour cost.

1 watt = .01 Kilowatt

100 watts = .1 Kilowatt

1000 watts = 1 Kilowatt

1 HP E+ WhisperFlo 1532 watts or 1.532 Kilowatt x \$.08 = \$.122 per hour

1 HP Max-E-Pro 1600 watts or 1.600 Kilowatt x \$.08 = \$.128 per hour

The pump does not require calculation for continuous watts since it is displayed on the screen in all modes. Just simply take the watts published on the screen, convert to kilowatts, and multiply by the kilowatt hour. The formula is:

210 watts = .210 kilowatt X \$.08 = \$.016 per hour

Remember to also consider the amount of water moved for the cost incurred (Water to Wire Efficiency). The pump cannot be matched in today’s industry for flow versus continuous watts at any speed by any other pump in pool. The Filter mode and flow control further assists in cost saving by always allowing the pump to do the least amount of work at all times.

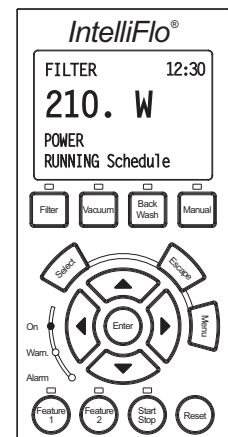

How to make your pool more energy efficient

Swimming pools are great for relaxing, exercising or just having fun. But they also mean higher than average energy bills. The key to saving energy with your pool is to correctly manage the filter pump time, pool temperature and lighting. Consider the following when operating your swimming pool:

Using your IntelliFlo® VF Variable Flow Pump

Your pool needs to be filtered every 24 hours. The time to filter the pool depends on:

- The size of your pool.
- The filtering equipment.
- How much you use your pool.
- Different environmental factors (such as how much sunlight hits the pool).

Typically, one complete turnover of water every 24 hours provides adequate filtering for a single-family pool. The more you use your pool, the more filtering it will need. It is generally recommended that you run your filter for four to six hours a day during the summer and two to four hours a day during the winter. If you're filtering more than this, try reducing your daily filtering time by 30 minutes. After a week, if the water clarity and chemical balance show adequate filtration is taking place, try reducing your filtering time by another 30 minutes. Continue this process until water clarity or chemical imbalance indicates more filtering is needed. In addition to chemical testing, a good way to check your water clarity is that the main drain cover should be clearly visible from the deck.

Automatic pool sweeps (booster pump style)

Usually, three to four hours of daily operation during summer and two to three hours daily in the winter are sufficient. Start the pool sweep one hour or more after the pool pump has started and stop the sweep one hour or more before the pool pump turns off. On unusually dusty days, increase cleaning time in half-hour increments until the pool is clean. Use a wall brush and leaf skimmer frequently to help the sweep along.

Filter during off-peak times

You can help everyone by filtering your pool during off-peak hours. Avoid operating your pool filter between the hours of noon and 6 P.M. This will help reduce the demand for electricity, conserve natural resources, and save money. Of course, if your pool has solar heating, you'll need to filter when the sun is correctly positioned for your solar panels. However, we recommend that you minimize filtration during the peak period of noon to 6 P.M. as much as possible.

Setting filtering time

A filter time clock is an easy way to manage pool filtering. Just be sure to check it once a month to make sure the trippers are secure. Check your clock's instruction manual for directions on setting the operation times. Remember to reset the time clock after power outages and for the fall and spring time change.

Preventive Maintenance

Follow a regular program of preventive maintenance, including an annual inspection of the heat exchanger to help maintain heating efficiency.

Ultra Energy Efficient IntelliFlo® Pump

When its time to replace your old motor and pump assembly, consider using the IntelliFlo variable speed energy-efficient pump. It moves more water more efficiently, and can help you reduce your filter operating time by hours. IntelliFlo pumps can automatically control tasks like pool vacuuming, filtering and backwashing, operating the automatic pool sweep and pump operation for the pool/spa combination. Once these tasks are done, the IntelliFlo pump automatically ramps down to low speed for your pool's daily filtration cycle, which can save energy and money for you.



LIT. PKG. P/N 350118



1620 HAWKINS AVE., SANFORD, NC 27330 • (919) 566-8000
10951 WEST LOS ANGELES AVE., MOORPARK, CA 93021 • (805) 553-5000

WWW.PENTAIRPOOL.COM

All Pentair trademarks and logos are owned by Pentair or one of its global affiliates. Pentair Aquatic Systems®, IntelliFlo®, IntelliComm®, EasyTouch®, IntelliTouch®, SunTouch® and Eco Select® are trademarks and/or registered trademarks of Pentair Water Pool and Spa, Inc. and/or its affiliated companies in the United States and/ or other countries. Unless expressly noted, names and brands of third parties that may be used in this document are not used to indicate an affiliation or endorsement between the owners of these names and brands and Pentair Water Pool and Spa, Inc. Those names and brands may be the trademarks or registered trademarks of those third parties. Because we are continuously improving our products and services, Pentair reserves the right to change specifications without prior notice. Pentair is an equal opportunity employer.

© 2016 Pentair Water Pool and Spa, Inc. All rights reserved. This document is subject to change without notice.



P/N 350075 Rev. G 11/9/16