

742/762 Control Performa Cv Series Valves

Operation Manual

For Sales & Service questions please contact
your dealer:

Your local dealer is:

TABLE OF CONTENTS

LOGIX™ SERIES INSTALLER QUICK-START SHEET	3
MANUAL OVERVIEW	8
How To Use This Manual	
General Warnings And Safety Information	
EQUIPMENT INSTALLATION	9
Valve Features	
Location Selection	
Water Line Connection	
Drain Line Connection	
Overflow Line Connection	
Regenerant Line Connection	
Electrical Connection	
Valve Camshaft	
SYSTEM DISINFECTION	22
Disinfection Of Water Conditioners	
DETERMINING IF YOU HAVE A 742 OR 762 CONTROL	24
GENERAL 700 SERIES INSTRUCTIONS	25
Display Icons 700 Controller	
Keypad — Buttons	
Regeneration Modes	
742/762 Series Initial Power-Up	
Initial Start-up Step-By-Step Instructions	
PLACING CONDITIONER INTO OPERATION (turning on the water)	35
PROGRAMMING THE 700 FOR 5-CYCLE FILTER APPLICATIONS	38
Manganese Greensand Systems	
742/762 SERIES ADVANCED PROGRAMMING	41
742/762 Level II Professional Programming	42
PARTS AND ACCESSORIES	45
Performa Exploded View	
Performa Parts List	
Logix 700 Series Controllers Parts List	
TROUBLESHOOTING	48

LOGIX™ SERIES INSTALLER QUICK-START SHEET

Logix Series Controllers

See *Determining If You Have a 742 or 762 Control* on page 24 to identify your controller.

742 Controller - Electronic time clock control capable of doing 7-day (day of week) regeneration, or up to a 99 interval day regeneration. This control will operate both in a conditioner (softener) or 3-cycle filter mode with the same controller.

762 Controller - Electronic metered-demand (volumetric) controller which regenerates based on the water usage of the installation site. A calendar override is a standard feature on this controller.

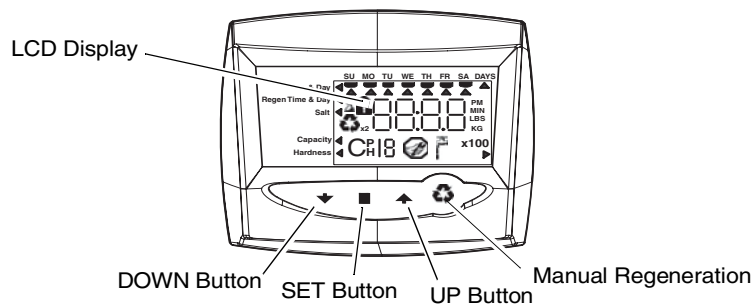

For 5-cycle filter applications, see page 38 for setting details.

Initial Power-up

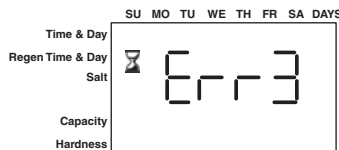

Initial Power Up - (CAMSHAFT proceeds to HOME position)

- At initial power-up, the camshaft will need to rotate to the HOME (in service) position.
- Camshaft may take 1-2 minutes to return to home position.
- Err 3 will be displayed until the camshaft returns to home.
- If more than 2 minutes elapses, verify that the motor is turning the camshaft. If it is not turning, see the troubleshooting section.



NOTE: The Logix controller features a self-test sequence. At first power-up of the control, you may see a number such as 1.00, 1.02, 1.04, or 2.00 displayed. This is an indication that the self-test is not completed. To complete the test, verify that the turbine cable is connected. Blow into the turbine port (valve outlet) to spin the turbine. The controller will verify that the turbine works and the self test will finish. Proceed with the initial start up procedure.

Initial Start-up Step-by-step Instructions

Step 1: Select Valve Type

This step may have been performed by your system's OEM manufacturer. In this case, proceed to step 3.

- Identify your valve body type by looking at the silver ID sticker on the back or side of the valve body.
- Select your valve body type using the UP or DOWN buttons.
- Display Valve Body
 - 255 255, 7-cycle conditioner
 - 263 Performa filter 263, 3-cycle filter
 - 268 Performa conditioner 268, 7-cycle conditioner
 - 273 Performa Cv 273, 3-cycle filter
 - 278 Performa Cv 278, 5-cycle conditioner
 - 293 Magnum Cv filter, 3-cycle filter
 - 298 Magnum Cv conditioner, 7-cycle conditioner



NOTE: Different 742/762 control hardware is necessary to operate the 150S valve body.

Step 2: Program System Size

This step may have been performed by your system's OEM manufacturer. In this case, proceed to step 3.

- Input system size - resin volume - in cubic feet or liters.
- Use UP and DOWN buttons to scroll through resin volume choices.
- Choose the nearest volume to your actual system size.
- To choose a 3-cycle filter operation - press DOWN until an "F" is displayed.
- Press SET to accept the system size you've selected.
- If incorrect setting is programmed, see "Resetting the Control" section below.

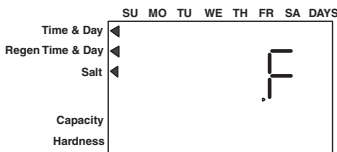
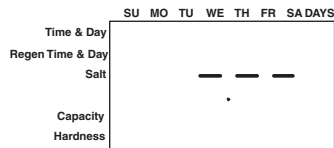

Step 3: Program Time of Day

- While "12:00" is blinking, set the correct time of day.
- Use the UP and DOWN buttons to scroll to the correct time of day.
- "PM" is indicated, "AM" is not indicated.
- Press SET to accept the correct time of day and advance to the next parameter.



Step 4: Set Day of Week

- Press SET to make the arrow under SU flash.
- Use the UP and DOWN buttons to advance the arrow until it is under the correct day of week.
- Press SET to accept and advance to the next parameter.

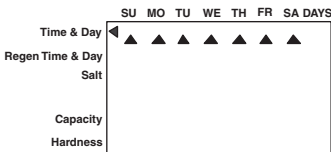

Step 5: Set Regen Time

- 2:00 (AM) is the default time of regeneration. To accept this time, press the DOWN button to move to step 6.
- To change the regen time, press SET - causing 2:00 to flash.
- Use the UP and DOWN buttons to advance to the desired regen time.
- Press SET to accept the time and advance to the next parameter.

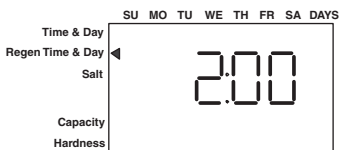

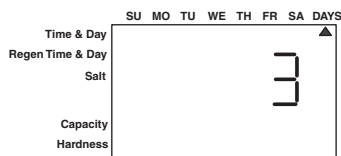

Step 6: Set Days to Regenerate (742 Time-clock Control Only)

- If using 762 control - proceed to step 6a.
- Set number of days between time-clock regeneration (regen frequency).
- Default time is 3 days.
- Days can be adjusted from 1/2 (.5) to 99 days.
- To change, press SET to make the "3" flash.
- Use the UP and DOWN buttons to change to the number of days desired.
- Press SET to accept the regen frequency, and advance to the next cycle.

To use the 7-day timer option - see full Dealer Installation Manual.

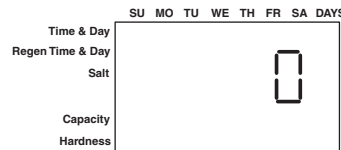

Step 6a: Set Calendar Override (762 Demand Control Only)

- If using 742 control - proceed to step 7.
- Set number of days for calendar override on demand control.
- "0" days is the default for calendar override.
- Days can be adjusted from 1/2 (.5) to 99 days.
- To change, press SET to make the "0" flash.
- Use the UP or DOWN buttons to change to the number of days desired.
- Press SET to accept the regen frequency, and advance to the next cycle.



Step 7: Set Salt Amount (Regenerant Amount)

- Default setting is "9 pounds per ft³ (110 g/L).
- Use UP or DOWN to select regenerant amount.
- Press SET to accept the setting and advance to next parameter.

See page 32 for more complete information on regenerant settings for different system sizes, capacities and expected efficiencies.

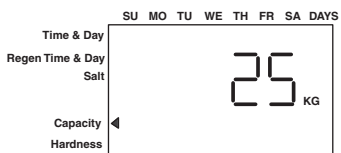

Step 8: Estimated Capacity

- System capacity is displayed in total kilograins or kilograms of hardness removed before a regeneration is necessary.
- Value is derived from the system's resin volume input, and salt amount input.
- The capacity displayed is a suggested value - as recommended by resin manufacturers.
- Capacity is only displayed for information purposes on 742 control - it does not (and cannot) need to be changed.
- To change capacity on 762 control, press SET to make the default capacity flash. Use the UP and DOWN buttons to increment to the desired capacity.
- Press SET to accept the setting and advance to the next parameter.

If using 742 control, programming is complete. The control will return you to the normal operation mode.

Step 9: Enter Hardness (762 Demand Control Only)

- Enter inlet water hardness at installation site.
- Default hardness setting is 25 grains (25 ppm for metric)
- To change hardness, press SET to make the setting flash. Use the UP and DOWN buttons to scroll to the correct hardness.
- Press SET to accept the entered hardness value.
- The control will return you to the normal operation mode.

Initial system programming is now complete. The control will return to normal operation mode, if a button is not pushed for 30 seconds.

For system start-up procedure, including: purging the mineral tank, refilling the regenerant tank, and drawing regenerant, see *Initial Startup Step-By-Step Instructions* on page 30.

Manual Regeneration Procedures

To Initiate a Manual Regeneration:

- Press REGEN once for delayed regeneration. System will regenerate at next set regen time (2:00 AM). A flashing regen (recycle) symbol will be displayed.
- Press and hold REGEN for 5 seconds to initiate immediate manual regeneration. A solid regen symbol will be displayed.
- After immediate regeneration has begun, press REGEN again to initiate a second manual regeneration. An X2 symbol will be displayed, indicating a second regeneration will follow the first regeneration.

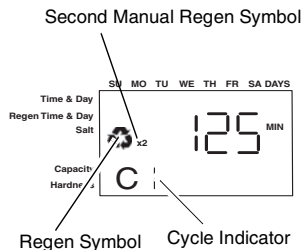

During a Regeneration:

- A "C#" is displayed to show current cycle.
- Total regen time remaining is displayed on screen.
- Press and hold SET to show current cycle time remaining.

To Advance Regeneration Cycles:

- Press and hold SET - showing current cycle time.
- Simultaneously press SET and UP to advance one cycle. An hourglass will display while cam is advancing. When cam reaches next cycle, "C2" will be displayed.
- Repeat SET and UP to advance through each cycle.
- Press and hold SET and UP buttons for 5 seconds to cancel regen. Hourglass will begin flashing, indicating regen is cancelled. Camshaft will advance to home - may take 1-2 minutes.

Regeneration Cycles:

- C1 - Backwash
- C2 - Regenerant Draw/Slow Rinse (not used in filter mode)
- C3 - Slow Rinse (not used in filter mode)
- C4 - System Pause (to repressurize tank)
- C5 - Fast rinse
- C8 - Regenerant refill (not used in filter mode)

Resetting The Control

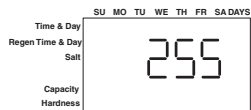
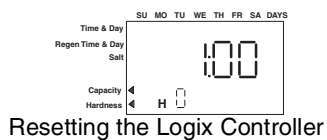

To reset the control:

1. Press and hold SET and DOWN simultaneously for 5 seconds.
2. H0 and the system's set resin volume (or "F" mode) will be displayed.
3. If a history value other than "H0" is displayed, use the up arrow to scroll through the settings until "H0" is displayed.
4. To reset the control, press and hold SET for 5 seconds.
5. The control will be reset to an unprogrammed state.
6. Go to "Initial Set-up" section of this sheet to reprogram control.



WARNING: Resetting the control will delete all information stored in its memory. This will require you to reprogram the control completely from the initial power up mode.

Further programming or set-up instructions can be found in this manual.

MANUAL OVERVIEW

How To Use This Manual

This installation manual is designed to guide the installer through the process of installing and starting conditioners featuring the 700 Logix series controllers.

This manual is a reference and will not include every system installation situation. The person installing this equipment should have:

- Training in the 700 Logix series controllers and water conditioner installation
- Knowledge of water conditioning and how to determine proper control settings
- Basic plumbing skills
- The directional instructions "left" and "right" are determined by looking at the front of the unit.

Left Side Right Side

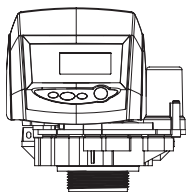

Icons That Appear In This Manual



WARNING: Failure to follow this instruction can result in personal injury or damage to the equipment.



NOTE: This will make the process easier if followed.

EQUIPMENT INSTALLATION

General Warnings And Safety Information

Electrical

There are no user-serviceable parts in the AC adapter, motor, or controller. In the event of a failure, these should be replaced.

- All electrical connections must be completed according to local codes.
- Use only the power AC adapter that is supplied.
- The power outlet must be grounded.
- To disconnect power, unplug the AC adapter from its power source.

Mechanical

- Do not use petroleum based lubricants such as vaseline, oils, or hydrocarbon based lubricants. Use only 100% silicone lubricants.
- All plastic connections should be hand tightened. Teflon tape may be used on connections that do not use an O-ring seal. **Do not use pliers or pipe wrenches.**
- All plumbing must be completed according to local codes.
- Soldering near the drain line should be done before connecting the drain line to the valve. Excessive heat will cause interior damage to the valve.
- Observe drain line requirements.
- Do not use lead-based solder for sweat solder connections.
- The drain line must be a minimum of 1/2-inch diameter. Use 3/4-inch pipe if the backwash flow rate is greater than 7 gpm (26.5 Lpm) or the pipe length is greater than 20 feet (6 m).
- Do not support the weight of the system on the control valve fittings, plumbing, or the bypass.
- It is not recommended to use sealants on the threads. Use Teflon* tape on the threads of the 1-inch NPT elbow, the drain line connections, and other NPT threads.

*Teflon is a trademark of E.I. duPont de Nemours.

General

- Observe all warnings that appear in this manual.
- Keep the media tank in the upright position. Do not turn on side, upside down, or drop. Turning the tank upside down will cause media to enter the valve.
- Operating ambient temperature is between 34°F (1°C) and 120°F (49°C).
- Operating water temperature is between 34°F (1°F) and 100°F (38°C).
- Working water pressure range is 20 to 120 psi (1.38 to 8.27 bar). In Canada the acceptable working water pressure range is 20 to 100 psi (1.38 to 6.89 bar).
- Use only regenerant salts designed for water softening. Do not use ice melting, block, or rock salts.
- Follow state and local codes for water testing. Do not use water that is micro biologically unsafe or of unknown quality.
- When filling media tank, do not open water valve completely. Fill tank slowly to prevent media from exiting the tank.
- When installing the water connection (bypass or manifold) connect to the plumbing system first. Allow heated parts to cool and cemented parts to set before installing any plastic parts. Do not get primer or solvent on O-rings, nuts, or the valve.

System Regeneration Cycles (5-Cycle Operation)

1. Service (Downflow) — Cycle C0:

Untreated water is directed down through the resin bed and up through the riser tube. The hardness ions attach themselves to the resin and are removed from the water. The water is conditioned as it passes through the resin bed.

2. Backwash (Upflow) — Cycles C1:

The flow of water is reversed by the control valve and directed down the riser tube and up through the resin bed. During the backwash cycle, the bed is expanded and debris is flushed to the drain.

3. Brine/Slow Rinse (Downflow) — Cycles C2, C3:

The control directs water through the brine injector and brine is drawn from the regenerant tank. The brine is then directed down through the resin bed and up through the riser tube to the drain. The hardness ions are displaced by sodium ions and are sent to the drain. The resin is regenerated during the brine cycle. Brine draw is completed when the air check closes.

4. Repressurize Cycle (Hard Water Bypass Flapper Open) — Cycle C4:

This cycle allows the air and water to hydraulically balance in the valve before continuing the regeneration.

5. Brine Refill — Cycle C8:

Brine refill occurs during a portion of the fast rinse cycle. Water is directed to the regenerant tank at a controlled rate, to create brine for the next regeneration.

Figure 1

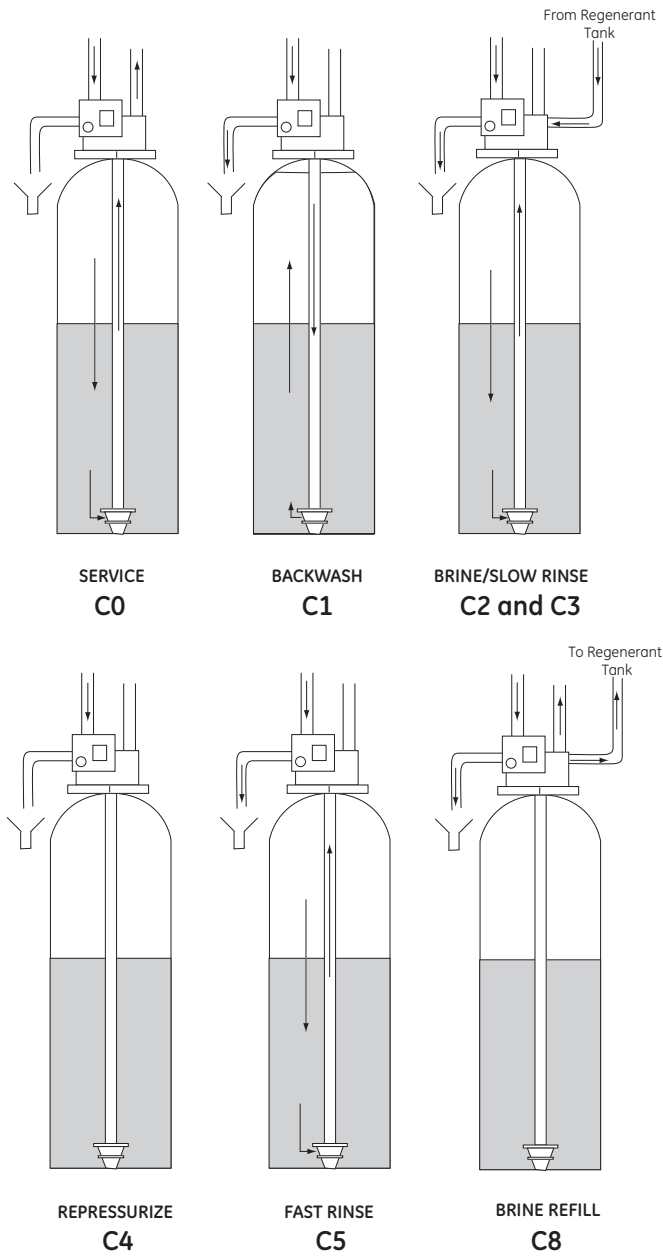

Valve Features

Figure 2
Performa Valve Identification

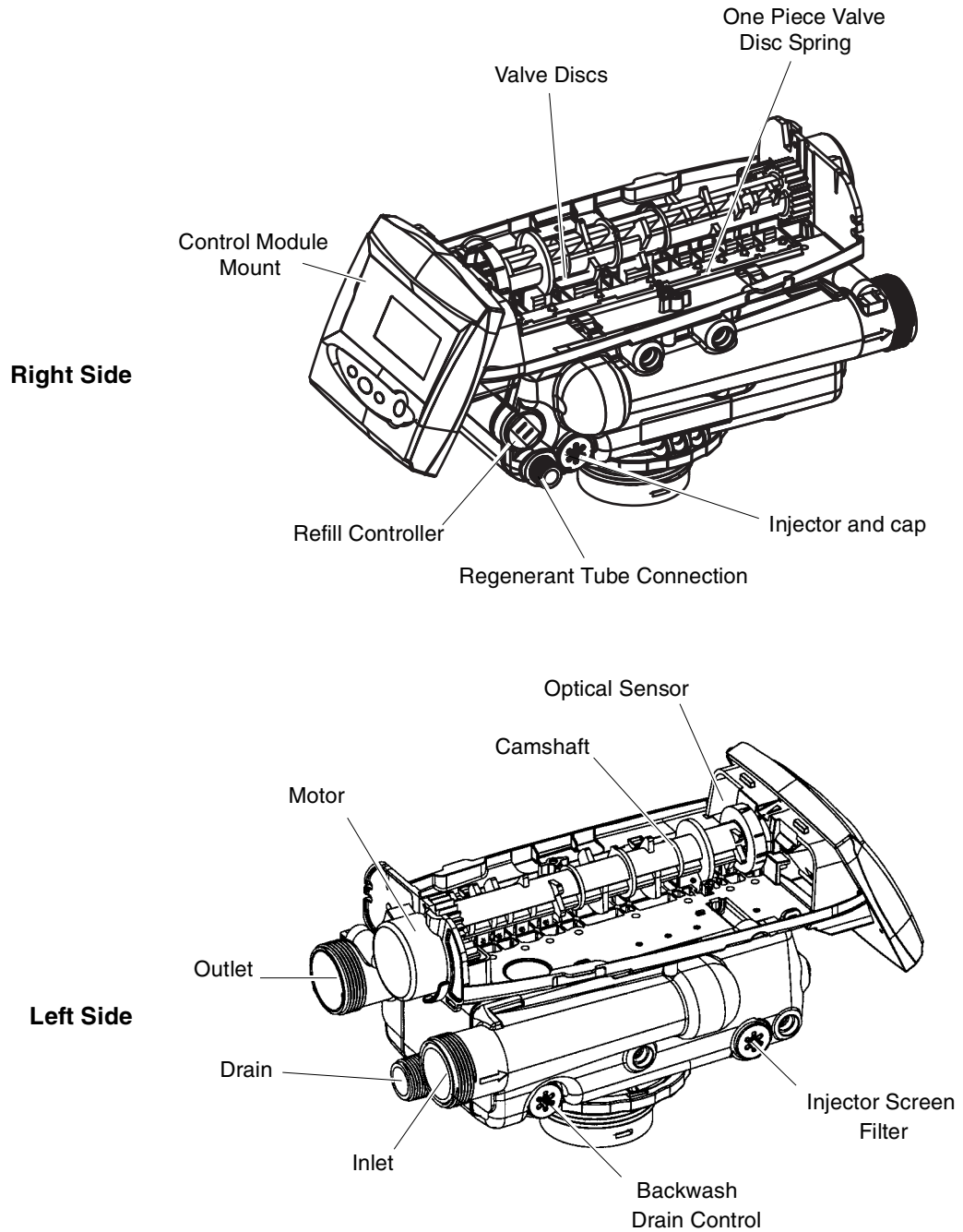
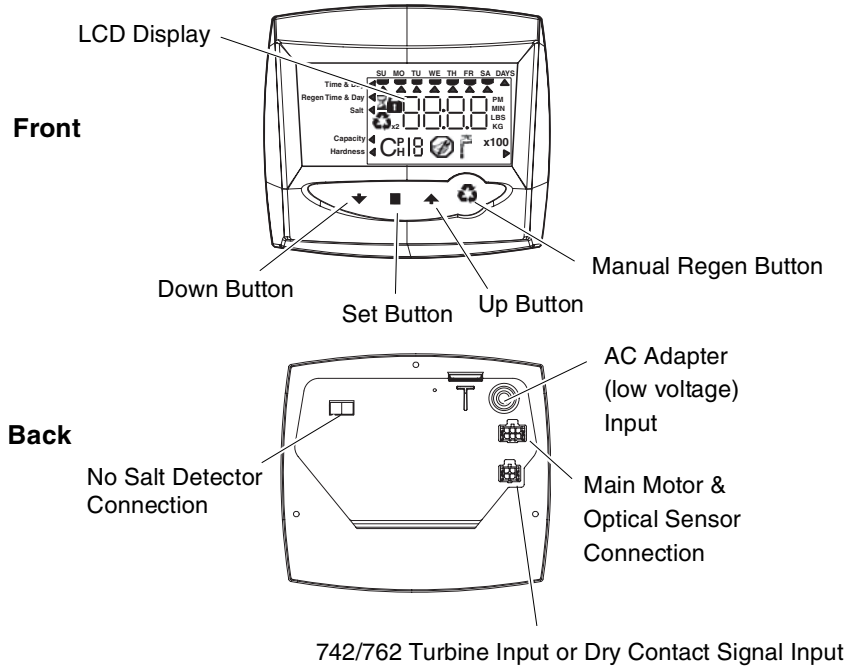

Figure 3
700 Series Controller Identification



Location Selection

Location of a water treatment system is important. The following conditions are required:

- Level platform or floor
- Room to access equipment for maintenance and adding regenerant (salt) to tank.
- Ambient temperatures over 34°F (1°C) and below 120°F (49°C).
- Water pressure below 120 psi (8.27 bar) and above 20 psi (1.4 bar).
- In Canada the water pressure must be below 100 psi (6.89 bar).
- Constant electrical supply to operate the controller.
- Total minimum pipe run to water heater of ten feet (three meters) to prevent backup of hot water into system.
- Local drain for discharge as close as possible.
- Water line connections with shutoff or bypass valves.
- Must meet any local and state codes for site of installation.
- Valve is designed for minor plumbing misalignments. Do not support weight of system on the plumbing.
- Be sure all soldered pipes are fully cooled before attaching plastic valve to the plumbing.

Outdoor Locations

When the water conditioning system is installed outdoors, several items must be considered.

- **Moisture** — The valve and 700 controller are rated for NEMA 3 locations. Falling water should not affect performance. The system is not designed to withstand extreme humidity or water spray from below. Examples are: constant heavy mist, near corrosive environment, upwards spray from sprinkler.
- **Direct Sunlight** — The materials used will fade or discolor over time in direct sunlight. The integrity of the materials will not degrade to cause system failures. If it is necessary to locate the conditioner in direct sunlight, a protective outdoor cover (P/N 1267811) over the valve and controller is necessary.
- **Temperature** — Extreme hot or cold temperatures may cause damage to the valve or controller. Freezing temperatures will freeze the water in the valve. This will cause physical damage to the internal parts as well as the plumbing. High temperatures will affect the controller. The display may become unreadable but the controller should continue to function. When the temperature drops down into normal operating limits the display will return to normal. A protective cover, P/N 1267811, should assist with high temperature applications.
- **Insects** — The controller and valve have been designed to keep all but the smallest insects out of the critical areas. Any holes in the top plate can be covered with a metal foil duct work tape. The top cover should be installed securely in place.
- **Wind** — The Logix cover is designed to withstand a 30 mph (48 Kph) wind when properly installed on the valve.

Water Line Connection

A bypass valve system should be installed on all water conditioning systems. Bypass valves isolate the conditioner from the water system and allow unconditioned water to be used. Service or routine maintenance procedures may also require that the system is bypassed. Figures 4 and 5 show the three common bypass methods.

Figure 4
 Series 1265 bypass for use with Performa valve bodies

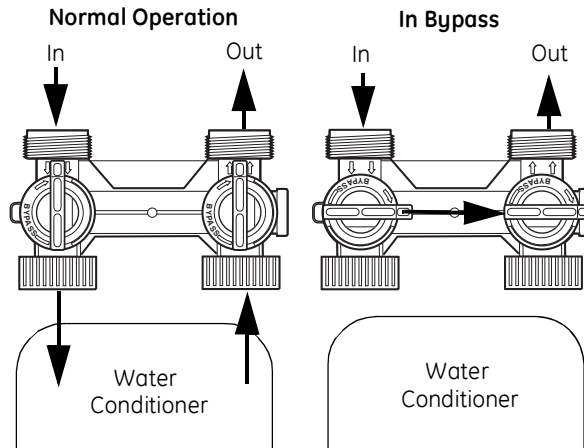
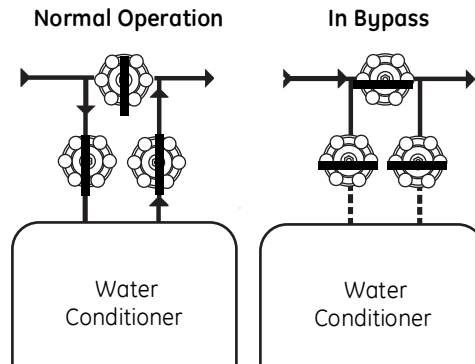



Figure 5
 Typical Globe Valve Bypass System





WARNING: The inlet water must be connected to the inlet port of the valve. When replacing non-Pentair Water valves, the inlet and outlet may be reversed. It is also possible for the plumbing to be installed in an opposite order.
 Do not solder pipes with lead-based solder.



WARNING: Do not use tools to tighten plastic fittings. Over time, stress may break the connections. When the 1265 or 256 bypass valve is used, only hand tighten the plastic nuts.



WARNING: Do not use petroleum grease on gaskets when connecting bypass plumbing. Use only 100% silicone grease products when installing any plastic valve. Non-silicone grease may cause plastic components to fail over time.

Drain Line Connection



NOTE: Standard commercial practices are expressed here. Local codes may require changes to the following suggestions. Check with local authorities before installing a system.

1. The unit should be above and not more than 20 feet (6.1 m) from the drain. Use an appropriate adapter fitting to connect 1/2-inch (1.3 cm) plastic tubing to the drain line connection of the control valve.
2. If the backwash flow rate exceeds 5 gpm (22.7 Lpm) or if the unit is located 20-40 feet (6.1-12.2 m) from drain, use 3/4-inch (1.9 cm) tubing. Use appropriate fittings to connect the 3/4-inch tubing to the 3/4-inch NPT drain connection on valve.
3. The drain line may be elevated up to 6 feet (1.8 m) providing the run does not exceed 15 feet (4.6 m) and water pressure at the conditioner is not less than 40 psi (2.76 bar). Elevation can increase by 2 feet (61 cm) for each additional 10 psi (.69 bar) of water pressure at the drain connector.
4. Where the drain line is elevated but empties into a drain below the level of the control valve, form a 7-inch (18-cm) loop at the far end of the line so that the bottom of the loop is level with the drain line connection. This will provide an adequate siphon trap.

Where the drain empties into an overhead sewer line, a sink-type trap must be used.

Secure the end of the drain line to prevent it from moving.

Figure 6
Drain Line Connection

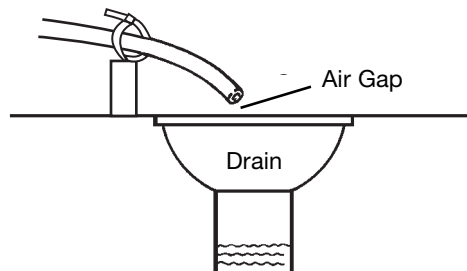

NOTE: Waste connections or drain outlet shall be designed and constructed to provide for connection to the sanitary waste system through an air-gap of 2 pipe diameters or 1 inch (22 mm) whichever is larger.



WARNING: Never insert drain line directly into a drain, sewer line, or trap (Figure 6). Always allow an air gap between the drain line and the wastewater to prevent the possibility of sewage being back-siphoned into the conditioner.

Overflow Line Connection (not used with 3-cycle filter system)

In the event of a malfunction, the regenerant TANK OVERFLOW will direct “overflow” to the drain instead of spilling on the floor. This fitting should be on the side of the cabinet or regenerant tank. Most tank manufacturers include a post for the tank overflow connector.

To connect the overflow line, locate hole on side of tank. Insert overflow fitting into tank and tighten with plastic thumb nut and gasket as shown (Figure 7). Attach length of 1/2-inch (1.3-cm) I.D. tubing (not supplied) to fitting and run to drain. Do not elevate overflow line higher than overflow fitting.

Do not tie into drain line of control unit. Overflow line must be a direct, separate line from overflow fitting to drain, sewer or tub. Allow an air gap as per drain line instructions.

Figure 7
Overflow Line Connection

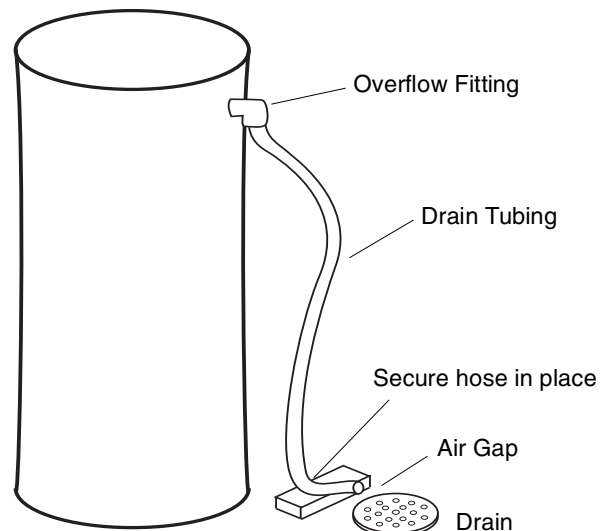

Regenerant Line Connection (not used with 3-cycle filter system)

The regenerant line from the tank connects to the valve. Make the connections and hand tighten. Be sure that the regenerant line is secure and free from air leaks. Even a small leak may cause the regenerant line to drain out, and the conditioner will not draw regenerant from the tank. This may also introduce air into the valve causing problems with valve operation.

Figure 8
Regenerant Connection for Performa Valve

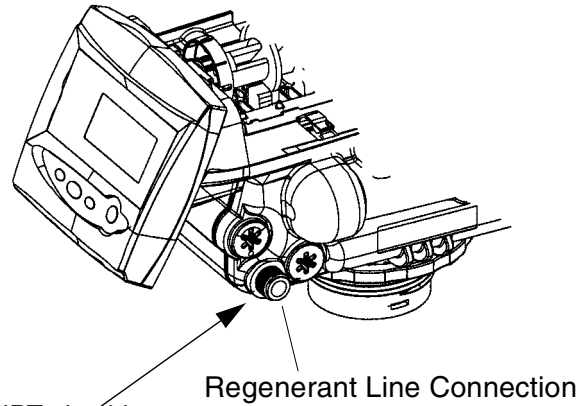

NOTE: Be sure to use a 3/8" NPT plumbing connection when attaching regenerant line to the Performa valve.



NOTE: When installing a 3-cycle filter (273 valve) use a cap on the regenerant line connection to prevent water seepage from the port. See *Parts and Accessories* section for part number.

An aircheck must be used in the regenerant line when installing a Performa valve.

Figure 9
 Regenerant Tank Check Valve (not provided)*

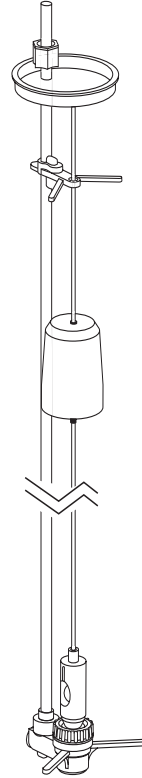

* Furnished as an option from conditioner system manufacturer.

Electrical Connection

CAUTION: This valve and control are for dry location use only unless used with a Listed Class 2 power supply suitable for outdoor use.

All 700 Series controllers operate on 12-volt alternating current power supply. This requires use of the supplied AC adapter. A variety of AC adapters are available for different applications. These AC adapters are available from your supplier. They include:

AC Adapter	Input Voltage	Application	Part Number
Standard wall-mount AC adapter	120V 60Hz	Standard indoor application	1000811
Outdoor rated AC adapter	120V 60Hz	UL listed for outdoor installations	1235448
International option AC adapters	Varies based on country	Standard indoor application	See Parts Lists Section

100 VAC, 120 VAC and 230 VAC AC Adapters:

Make sure power source matches the rating printed on the AC adapter.



NOTE: The power source should be constant. Be certain the AC adapter is not on a switched outlet. Power interruptions longer than 8 hours may cause the controller to lose the time and day settings. When power is restored, the day and time settings must then be re-entered.

The 700 Series controller is available in two power configurations. The North American controller operates on 60 Hz. If the incoming power is 50 Hz, the "North American" controller will not function. The error code "ERR 2" will show on the display.

The "World" controller will sense the input power as 50 or 60 Hz and operate accordingly.

Controller Location

The 700 Series controllers are designed to be mounted on the valve or attached to a flat surface. Installations that do not provide easy access to the valve can have the controller mounted for remote operation.

A remote mount connection, P/N 1256257, is available for the 700 Series controller.

Valve Camshaft

The front end of the camshaft has an indicator cup. The cup has slots in the outer periphery and numbers on the inside face (Figure 10).

The numbers can be seen with the cover off, from the front over the top of the controller. The number at the top indicates which regeneration cycle is currently in progress.

Figure 10
Camshaft Front End for 273 and 278 valve bodies

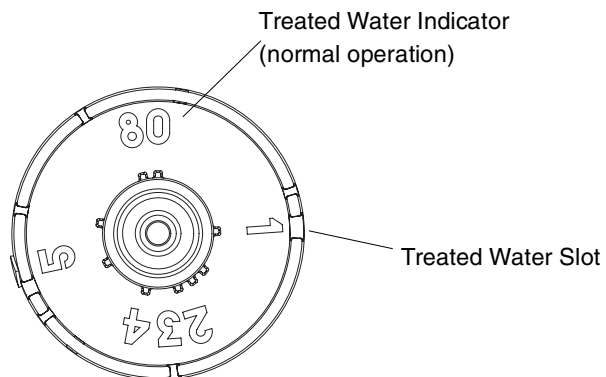

The corresponding slot for the number is positioned at the optical sensor which is approximately 90 degrees out of phase.

Regeneration Cycle Indicators

C0 = Treated Water - normal operation mode

- C1 = Backwash Cycle
- C2 = Regenerant Draw Cycle (not used in filter mode)
- C3 = Slow Rinse Cycle (not used in filter mode)
- C4 = System Pause (Repressurization cycle)
- C5 = Fast Rinse Cycle 1
- C8 = Regenerant Refill (not used in filter mode)

Valve Disc Operation

Figure 11 - Performa Valve (273, 278)

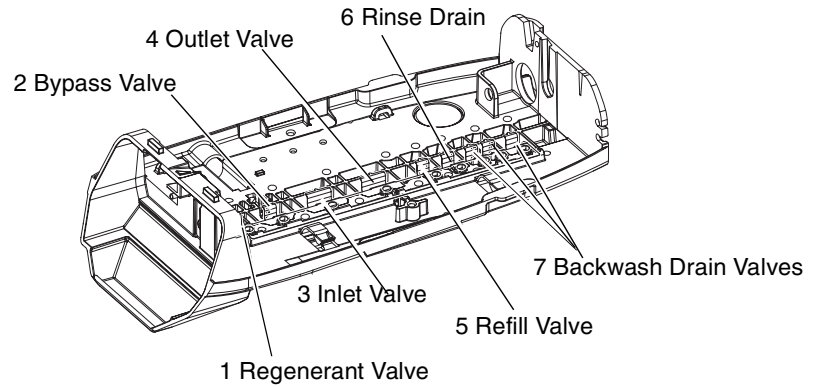

SYSTEM DISINFECTION

Disinfection Of Water Conditioners

The materials of construction of the modern water conditioner will not support bacterial growth, nor will these materials contaminate a water supply. During normal use, a conditioner may become fouled with organic matter, or in some cases with bacteria from the water supply. This may result in an off-taste or odor in the water.

Some conditioners may need to be disinfected after installation and some conditioners will require periodic disinfection during their normal life.

Depending upon the conditions of use, the style of conditioner, the type of ion exchanger, and the disinfectant available, a choice can be made among the following methods.

Sodium or Calcium Hypochlorite

Application

These materials are satisfactory for use with polystyrene resins, synthetic gel zeolite, greensand and bentonites.

5.25% Sodium Hypochlorite

These solutions are available under trade names such as Clorox*. If stronger solutions are used, such as those sold for commercial laundries, adjust the dosage accordingly.

1. Dosage
 - A. Polystyrene resin; 1.2 fluid ounce (35.5 mL) per cubic foot.
 - B. Non-resinous exchangers; 0.8 fluid ounce (23.7 mL) per cubic foot.
2. Brine tank conditioners
 - A. Backwash the conditioner and add the required amount of hypochlorite solution to the well of the regenerant tank. The regenerant tank should have water in it to permit the solution to be carried into the conditioner.
 - B. Proceed with the normal regeneration.

*Clorox is a trademark of the Clorox Company.

Calcium Hypochlorite

Calcium hypochlorite, 70% available chlorine, is available in several forms including tablets and granules. These solid materials may be used directly without dissolving before use.

1. Dosage
 - A. Two grains (approximately 0.1 ounce [3 mL]) per cubic foot.
2. Regenerant tank conditioners
 - A. Backwash the conditioner and add the required amount of hypochlorite to the well of the regenerant tank. The regenerant tank should have water in it to permit the chlorine solution to be carried into the conditioner.
 - B. Proceed with the normal regeneration.

DETERMINING IF YOU HAVE A 742 OR 762 CONTROL

If you are unsure of your control model, simply remove the cover and disconnect the controller module from the control valve. In the back of the control valve is a silver label that will show your model number and version revision.

Figure 12

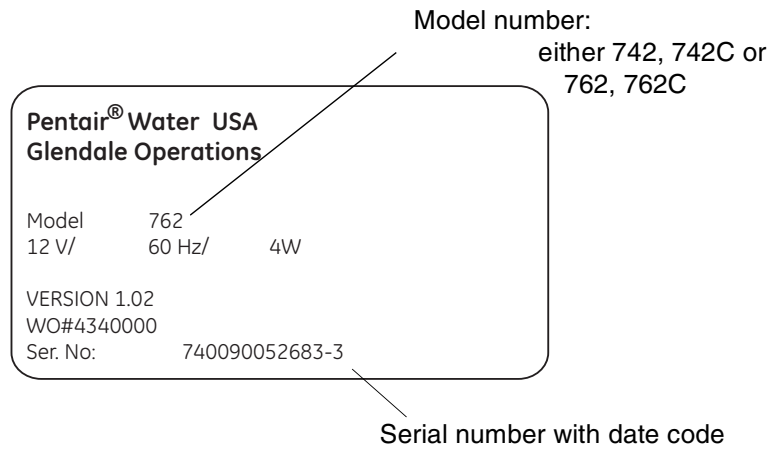

GENERAL 700 SERIES INSTRUCTIONS

Display Icons 700 Controller

Figure 13

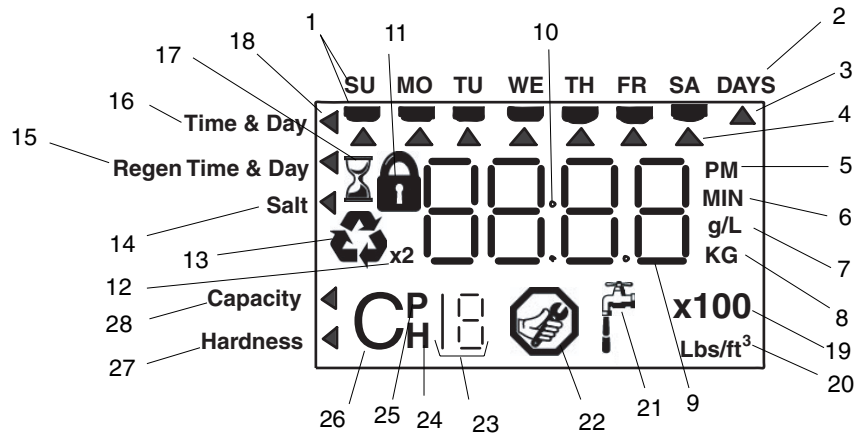

NOTE: In normal operation and during programming, only a few of the icons will actually be displayed.

1. Days of the week. The flag immediately below the day will appear when that day has been programmed as a day the system should regenerate (used with 7-day timer programming).
2. See #3
3. This cursor is displayed when the days between regeneration are being programmed (used with .5 to 99 day regeneration programming).
4. One of these cursors will be displayed to indicate which day will be programmed into the controller.
5. "PM" indicates that the time displayed is between 12:00 noon and 12:00 midnight (there is no AM indicator). PM indicator is not used if clock mode is set to 24-hour.
6. When "MIN" is displayed, the value entered is in minute increments.
7. When g/L is displayed, the value for regenerant amount entered is in grams/Liter.
8. When "Kg" is displayed, the value entered is in kilograms or kilograins.
9. Four digits used to display the time or program value. Also used for error codes.

10. Colon flashes as part of the time display. Indicates normal operation (742 only).
11. Locked/unlocked indicator. In Level I programming this is displayed when the current parameter is locked-out. It is also used in Level II programming to indicate if the displayed parameter will be locked (icon will flash) when controller is in Level I.
12. When "x2" is displayed, a second regeneration has been called for.
13. The recycle sign is displayed (flashing) when a regeneration at the next time of regeneration has been called for. Also displayed (continuous) when in regeneration.
14. The display cursor is next to "SALT" when programming the amount of regenerant. If the controller is on a 3-cycle filter then backwash time is programmed.
15. The display cursor is next to "REGEN TIME & DAY" when programming the time of regeneration and the days of regeneration.
16. The display cursor is next to "TIME & DAY" when programming the current time and day.
17. The hourglass is displayed when the motor is running. The camshaft should be turning.
18. These cursors will appear next to the item that is currently displayed.
19. X100 multiplier for large values.
20. When Lbs/ft³ is displayed the value for regenerant amount entered is in pounds/cubic foot.
21. Faucet is displayed when the current flow rate is displayed. Control may show the faucet and "0", indicating no flow.
22. Maintenance interval display turns on if the months in service exceed the value programmed in P11.
23. Used with #24, #25, and #26. Displays a sequence number or a value.
24. History Values (H). The number displayed by #23 identifies which history value is currently displayed.
25. Parameter (P). Displayed only in Level II Programming. The number displayed by #23 identifies which parameter is currently displayed.
26. Cycle (C). The number displayed by #23 is the current cycle in the regeneration sequence.
27. Hardness setting—only used with 762 controllers.
28. Capacity display—shows estimated system capacity.

Keypad — Buttons

Figure 14

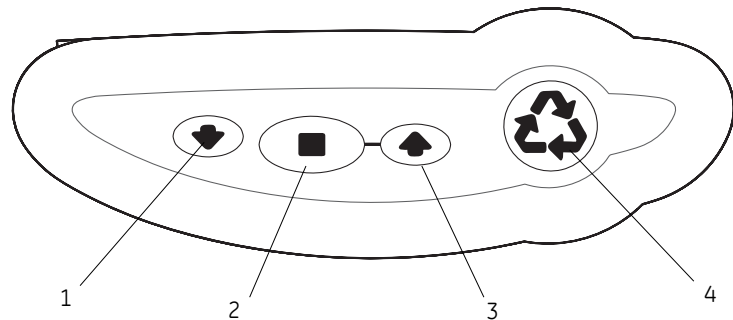

1. DOWN arrow. Generally used to scroll down or increment through a group of choices.
2. SET. Used to accept a setting that normally becomes stored in memory. Also used together with the arrow buttons.
3. UP arrow. Generally used to scroll up or increment through a group of choices.
4. Regenerate. Used to command the controller to regenerate. Also used to change the lock mode.



NOTE: If a button is not pushed for thirty seconds, the controller returns to normal operation mode. Pushing the Regenerate button immediately returns the controller to normal operation.





Programming Conventions

The 700 series controller is programmed using the buttons on the keypad. The programming instructions will be described two ways whenever a section has keypad input.

First, a table shows simplified instructions. Second, text follows that describes the action. In each table:

"Action" lists the event or action desired.

"Keys" are listed as:

-  UP for up arrow
-  DOWN for down arrow
-  SET for set
-  REGEN for regeneration

"Duration" describes how long a button is held down:

P/R for press and release

HOLD for press and hold

X sec for a number of seconds to press the button and hold it down

"Display" calls out the display icons that are visible.

Regeneration Modes

The 700 Series controllers can be regenerated either automatically or manually. During a regeneration, the total time remaining of the regeneration will be displayed on the controller. The current cycle is shown in the lower left of the display.

To Initiate a Manual Regeneration:

- Press REGEN once for delayed regeneration. System will regenerate at next set regen time (2:00 AM).
A flashing regen (recycle) symbol will be displayed.
- Press and hold REGEN for 5 seconds to initiate immediate manual regeneration. A solid regen symbol will be displayed.
- After immediate regeneration has begun, press REGEN again to initiate a second manual regeneration. A flashing "x2" symbol indicates the second regeneration will start at the time of regeneration. Press and hold REGEN to turn on the second regeneration immediately following the current regeneration. The double regeneration is indicated by the "x2" symbol being on steady.

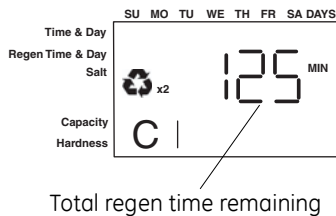

During a Regeneration:

- A "C#" is displayed to show current cycle.
- Total regen time remaining is displayed on screen.
- Press and hold SET to show current cycle time remaining.

To Advance Regeneration Cycles:

- Press and hold SET - showing current cycle time.
- Simultaneously press SET and UP to advance on cycle. An hourglass will display while cam is advancing.
When cam reaches next cycle, "C2" will be displayed.
- Repeat SET and UP to advance through each cycle.
- Press and hold SET and UP for 5 seconds to cancel regen.
Hourglass will flash once cancelled.
Camshaft will advance to home – may take 1 to 2 minutes.

Regeneration Cycles:

- C1 – Backwash
- C2 – Regeneration Draw/Slow Rinse (not used in filter mode)
- C3 – Slow Rinse (not used in filter mode)
- C4 – System Pause (to repressurize tank)
- C5 – Fast Rinse
- C8 – Regenerant Refill (not used in filter mode)

742/762 Series Initial Power-Up

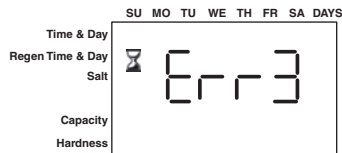

Initial Power Up – (Camshaft proceeds to HOME position)

- At initial power-up, the camshaft may need to rotate to the HOME (in service position).
- Camshaft may take 1 to 2 minutes to return to HOME position.
- Err 3 will be displayed until the camshaft returns to HOME position.
- If more than 2 minutes elapses, verify that the motor is turning the camshaft. If it is not turning, contact Dealer.



NOTE: The 700 Series controller features a self-test sequence. At first power-up of the control, you may see a number such as 1.00, 1.02, 1.04, or 2.00 displayed. This is an indication that the self-test is not completed. To complete the test, verify that the turbine cable is connected. Blow air into the turbine port (valve outlet) to spin the turbine. The controller will verify that the turbine works and the self-test will finish. Proceed with the initial start-up procedure.

Initial Start-up Step-By-Step Instructions

For FA filter applications, please program as normal below. See section *Programming the 700 for 5-Cycle Filter Applications*.

Step 1: Select Valve Type

This step may have been performed by your system's OEM manufacturer. In this case, proceed to step 3.

- Identify your valve body type by looking at the silver ID sticker on the back or side of the valve body.
- Select your valve body type using the UP and DOWN buttons.
- Display
Valve Body
255 255, 7-cycle conditioner
263 Performa filter 263, 3-cycle filter
268 Performa conditioner 268, 7-cycle conditioner
273 Performa Cv 273, 3-cycle filter
278 Performa Cv 278, 5-cycle conditioner
293 Magnum Cv filter, 3-cycle filter
298 Magnum Cv conditioner, 7-cycle conditioner



NOTE: Different 742/762 control hardware is necessary to operate the 150S valve body.

	SU	MO	TU	WE	TH	FR	SA	DAYS
Time & Day								
Regen Time & Day								
Salt				---	---	---		
Capacity				.				
Hardness								

Step 2: Program System Size

This step may have been performed by your system's OEM manufacturer. In this case, proceed to step 3.



NOTE: Capacity is the result of the amount of media in the tank and the salt setting. The default capacity will be changed by selecting a different regenerant setting.

- Input system size – media volume (For FA filters, choose your closest media volume) – in cubic feet or liters.
- Use UP and DOWN buttons to scroll through resin volume choices.
- Choose the nearest volume to your actual system size.
- Press SET to accept the system size you've selected.
- If incorrect setting is programmed, see "Resetting the Control" section below.



NOTE: If the controller was incorrectly set to the wrong valve body, press the DOWN button and SET button for five seconds to display resin volume in "HO". Press and hold the SET button for five seconds to reset the controller. Use the UP or DOWN buttons to increment the display to the correct valve body. Press SET.

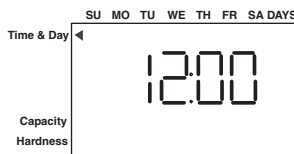

Set 3: Program Time of Day

- While “12:00” is blinking, set the correct time of day.
- Use the UP and DOWN buttons to scroll to the correct time of day.
- “PM” is indicated, “AM” is not indicated.
- Press SET to accept the correct time of day and advance to the next parameter.

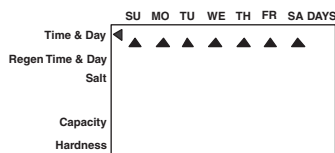

Step 4: Set Day of Week

- Press SET to make the arrow under “SU” flash.
- Use the UP and DOWN buttons to advance the arrow until it is under the correct day of week.
- Press SET to accept and advance to the next parameter.

After steps 1-4, the controller will operate most systems. Proceed to step 5 if further adjustments to your system’s programming is needed.

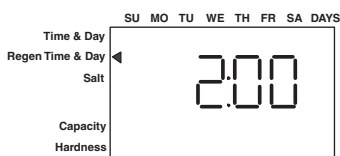

Step 5: Set Regen Time

- 2:00 (AM) is the default time of regeneration. To accept this time, press the DOWN button to move to step 6.
- To change the regen time, press SET – causing “2:00” to flash.
- Use the UP and DOWN buttons to advance to the desired regen time.
- Press SET to accept the time and advance to the next parameter.

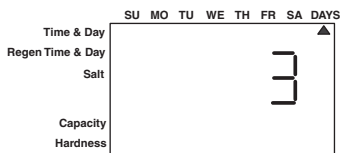

Step 6: Set Days to Regenerate (742 Time-Clock Control Only)

- If using 762 control – proceed to step 6a.
- Set number of days between time-clock regeneration (regen frequency).
- Default time is 3 days.
- Days can be adjusted from ½ (.5) to 99 days.
- To change, press SET to make the “3” flash.
- Use the UP and DOWN buttons to change the number of days desired.
- Press SET to accept the regen frequency, and advance to the next cycle.



WARNING: 742 only: Setting days between regeneration to zero will cause the system to not regenerate. This setting is used for selecting regeneration on specific days or to use with a remote regeneration input.

- To use the 7-day timer option –see *Dealer Installation Manual*.

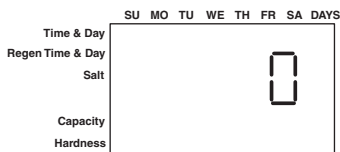

Step 6a: Set Calendar Override (762 Demand Control Only)

- If using 742 control – proceed to step 7.
- Set number of days for calendar override on demand control.
- “0” days is the default for calendar override.
- Days can be adjusted from ½ (.5) to 99 days.
- To change, press SET to make the “0” flash.
- Use the UP and DOWN buttons to change to the number of days desired. Press SET to accept the regen frequency, and advance to the next cycle.

Step 7: Amount of Regenerant used per Regeneration

If the installation is a filter, skip to *Filter Backwash Time*. The amount of regenerant does not apply.

- Select regenerant amount.
- The default setting is 9 lbs of salt per ft³ of resin (110 grams/Liter).
- The 255 and 268 valves will follow the high efficiency settings. See Table 1

Table 1- High Efficiency Exchange Capacity

Salt lbs/cu ft	Exchange Capacity grains/cu ft	Salt grams/liter	Exchange Capacity grams/liter
3	14100	50	33.6
4	18307	60	40.0
5	21160	70	44.5
6	23490	80	48.4
7	25460	90	51.8
8	27167	100	54.9
9	28673	110	57.7
10	30019	120	60.2
11	31238	130	62.6
12	32350	140	64.8
13	33373	150	66.8
14	34320	170	70.4
15	35202	200	75.2
16	36027	230	79.3
17	36802	260	82.9
18	37533	290	86.1

Table 2

To Convert Capacity in	Into Capacity in	Multiply by
kilograms (kg)	kilograins (kgr)	15.43
kilograins (kgr)	kilograms (kg)	0.0648
moles of CaCO ₃	kilograms (kg)	0.10
equivalents of CaCO ₃	kilograms (kg)	0.05

- To program the regenerant amount, press SET to enter the change mode. The 9 (lbs/ft³) default will begin to flash. Use UP and DOWN to scroll through the available settings. Press SET to enter the amount.

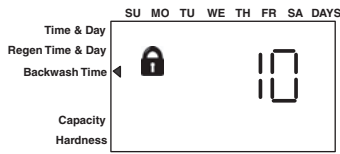

Filter backwash time (filter mode only)

If the system is set up as a filter, regenerant amount is unnecessary. The controller deactivates the regenerant amount setting, and changes to an adjustable backwash time in minutes.

- Press SET to change the time.
- The default time of 14 minutes will begin to flash.
- Use UP and DOWN to select the appropriate backwash time for the media type and amount used. The controller can use 0 to 99 minutes for backwash.
- Press SET again to enter that time.

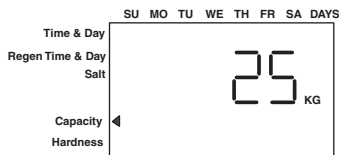

Step 8: Estimated Capacity

- System capacity is displayed in total kilograins or kilograms of hardness removed before a regeneration is necessary.
- Value is derived from the system's resin volume input, and salt amount input.
- The capacity displayed is a suggested value – as recommended by resin manufacturers.
- Capacity is only displayed for information purposes on 742 control – it cannot be changed.
- To change capacity on 762 control, press SET to make the default capacity flash. Use the UP and DOWN buttons to increment to the desired capacity.
- Press SET to accept the setting and advance to the next parameter.
- **FA filters:** see section on capacity, *Setting the 700 for 5-Cycle Filter Applications*.

If using the 742 control, programming is complete. The control will return you to the normal operation mode.

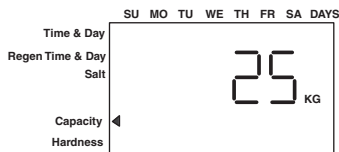

Step 9: Enter Hardness (762 Demand Control Only)

- Enter inlet water hardness at installation site.
- Default hardness setting is 25 grains (25 ppm for metric).
- To change hardness, press SET to make the setting flags. Use the UP and DOWN buttons to scroll to the correct hardness.
- Press SET to accept the entered hardness value.
- The control will return you to the normal operation mode.
- **FA filters:** see section on capacity, *Setting the 700 for 5-Cycle Filter Applications*.

Initial system programming is now complete. The control will return to normal operation mode, if a button is not pushed for 30 seconds.

Viewing Cycle Times

1. Press and hold the UP and SET buttons for 3 seconds when the control is in the "in service mode" to access the "cycle time display mode". The display will show a small "c" followed by a number in the lower portion of the display.
2. Press the UP and DOWN buttons to display the programmed cycle time.
3. Press the REGEN button to exit the "cycle times display mode".

Adjusting Cycle Times

1. Press SET when in the "cycle time display mode". The cycle time in minutes will flash, indicating the cycle time can be changed.
2. Press the UP or DOWN buttons to change the flashing time.
3. Press SET while the cycle time is flashing to enter the flashing value.



NOTE: The draw and refill cycle times cannot be changed in cycle time programming for conditioner valves. Draw and refill times are calculated using the draw and refill rates and salt amounts. The draw and refill cycle times may be programmed for 3-cycle filters.

PLACING CONDITIONER INTO OPERATION (turning on the water)

Conditioner and FA Filter Start-Up

After you have performed the previous initial power-up steps, you will need to place the conditioner into operation. Follow these steps carefully, as they differ from previous valve instructions.



WARNING: Do not rotate the camshaft by hand or damage to the unit may occur. Use the controller to step the camshaft electronically through the cycles.

1. Remove the cover from the valve. Removing the cover will allow you to see that the camshaft is turning, and in which cycle the camshaft is currently positioned.
2. With the supply water for the system still turned off, position the bypass valve to the “not in bypass” (normal operation) position.
3. Hold the REGEN button on the controller down for 5 seconds. This will initiate a manual regeneration.

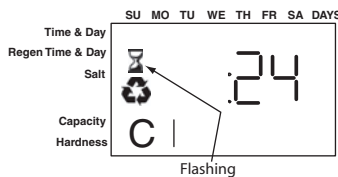

The controller will indicate that the motor is turning the camshaft to the cycle C1 (Backwash) position by flashing an hourglass. The controller will display the total regen time remaining.

If you press and hold the SET button, the controller will indicate the time remaining in the current cycle.

4. Fill the media tank with water.
 - A. While the controller is in cycle C1 (Backwash), open the water supply valve very slowly to approximately the 1/4 open position.



WARNING: If opened too rapidly or too far, media may be lost out of the tank into the valve or the plumbing. In the ¼ open position, you should hear air slowly escaping from the valve drain line.

- B. When all of the air has been purged from the media tank (water begins to flow steadily from the drain line), open the main supply valve all of the way. This will purge the final air from the tank.
- C. Allow water to run to drain until the water runs clear from the drain line. This purges any refuse from the media bed.
- D. Turn off the water supply and let the system stand for about five minutes. This will allow any air trapped to escape from the tank.

5. Add water to the regenerant tank (initial fill) (conditioner and FA filters only).
 - A. With a bucket or hose, add approximately 4 gallons (15 liters) of water to the regenerant tank.

If the tank has a salt platform in the bottom of the tank, add water until the water level is approximately 1 inch (25 mm) above the platform.



NOTE: We recommend that you do not put regenerant into the tank until after the control valve has been put into operation. With no regenerant in the tank, it is much easier to view water flow and motion in the tank.

6. Engage the refill cycle to prime the line between the regenerant tank and the valve (conditioner only).
 - A. Slowly open the main water supply valve again, to the fully open position. Be sure not to open too rapidly as that would push the media out of the media tank.
 - B. Advance the controller to the Refill (C8) position. From cycle C1 (Backwash), press and hold the SET button. This will display the current cycle.

While pressing the SET button, press UP to advance to the next cycle. Continue to advance through each cycle until you have reached cycle C8 (Refill).



NOTE: As you advance through each cycle there will be a slight delay before you can advance to the next cycle. The hourglass icon will light while the camshaft is indexing. There may be a pause at cycle C4 (System Pause). This cycle allows the water/air pressure to equalize on each side of the valve discs before moving on. The hourglass will not be visible indicating that the system is paused.

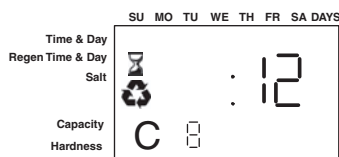

- C. With the water supply completely open, when you arrive at cycle C8 (Refill), the controller will direct water down through the line to the regenerant tank. Let the water flow through the line until all air bubbles have been purged from the line.
- D. Do not let the water flow down the line to the tank for more than one to two minutes, or the tank may overflow.
- E. Once the air is purged from the line, press the SET button and the UP button simultaneously to advance to cycle C0 (Treated Water) position.

7. Draw water from the regenerant tank.
 - A. From the treated water position (cycle C0), advance the valve to the draw regenerant position. Hold the REGEN button down for five seconds.

The controller will begin a manual regen, and advance the control valve to the cycle C1 (Backwash). Press the SET and UP button to advance to cycle C2 (Draw).

- B. With the controller in this position, check to see that the water in the regenerant tank is being drawn out of the tank. The water level in the tank should recede very slowly.
 - C. Observe the water being drawn from the regenerant tank for at least three minutes. If the water level does not recede, or goes up, check all hose connections. C2 should be displayed.
 8. If the water level is receding from the regenerant tank you can then advance the controller back to the treated water (C0) position by pressing SET and the UP buttons simultaneously to advance the controller to the C0 position.
 9. Finally, turn on a faucet plumbed after the water conditioner. Run the faucet until the water runs clear.

PROGRAMMING THE 700 FOR 5-CYCLE FILTER APPLICATIONS

Manganese Greensand Systems

Sizing FA Filters

Potassium permanganate regenerating iron filters should be sized for the appropriate backwash and injector sizes.

Backwash Controller

Be sure to choose the appropriate backwash flow rate control (see *Parts* section) as recommended by your media manufacturer.

Injector

Use the same injector size as you would for your conditioner control tank diameter.

Refill Controller

An FA filter can use the 0.33 gpm refill control that is featured as standard with a Logix controller. Use a check valve in your potassium permanganate feeder to prevent overflow.

Initial Resin Volume Setting

Programming for a manganese greensand system requires a few minor adjustments to the programming to operate the control correctly. The initial resin volume should be set to the closest volume of the manganese greensand in the system. For example, if the system contains two cubic feet of manganese greensand, program in 2.00 for the resin volume.

"Salt" Setting for $KMNO_3$ Regenerant

Be sure the regenerant (salt setting) is set high enough to operate the float shut off in the regenerant storage tank.

All other settings will remain the same as mentioned in the previous programming sections.

Days Between Regeneration Setting (742 FA)

To set the days between regenerations, consult the media manufacturer for the actual capacity of the media.

In general, manganese greensand has a capacity of 10,000 ppm of removal capability per cubic foot of media. Calculate the capacity of the system by taking the number of cubic feet of media and multiply by 10,000.

For example, using a 1 cubic foot system provides 10,000 ppm of removal capability.

The next step is to calculate the demand for the system. Multiply the predicted daily water usage by the iron content in ppm.

For example, an average person uses 75 gallons of water per day. Four people living in a home use 300 gallons of water (75 gallons x 4 people) per

day. Assume the incoming water has 10 ppm of iron. Now calculate the daily demand: multiply the gallons of water used per day (300) by the ppm of iron content (10) = 3000 ppm of daily capacity usage.

Now take the system capacity (10,000), divided by the daily demand (3,000) = 3.3 days of capacity. Since you will run out of capacity before the beginning of the fourth day, the proper setting for days between regeneration is 3 days.

For example:

4 people x 75 gals per person = 300 gallons used per day.

10 ppm iron x 300 gal/day = 3000 ppm/day

10,000 ppm capacity ÷ 3000 ppm/day = 3.3 days of total capacity

Solution = regenerate every 3 days.

Volume/Demand Regeneration Setting

To set a 762 demand system for iron removal you must:

1. Know your media capacity. Generally, one cubic foot of magnesium greensand can remove 10,000 ppm of iron.
2. Know the iron concentration in your water.

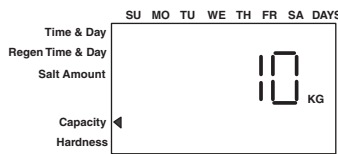

To have your system regenerate on demand, set your system's capacity (P7) to the appropriate factor. On the 762, it will read Kg, but you will actually be working in ppm of iron.

1. If your system is one cubic foot, set the capacity to "10" kg, meaning 10,000. For two cubic feet, set the capacity to "20" kg.
2. Set your hardness to the level of ppm iron in your water. If you have 3 ppm of iron, set the 762 control to "3".
3. The control will calculate the remaining volume capacity in gallons (m³) and count down to regeneration.

Things You Might Need to Know

- When the controller is first plugged in, it may display a flashing hourglass and the message Err 3, this means that the controller is rotating to the home position. If the Err 2 is displayed, check that the incoming power frequency matches the controller. The North American controller will not run with 50 Hz input.
- The preset default time of regeneration is 2:00 AM.
- English or Metric? The World controller senses the electrical input and decides which is needed. The North American controller only runs on 60 Hz and defaults to English units.
- The 700 Series controller can be programmed to regenerate on specific days of the week.
- If electrical power is not available, the camshaft can be rotated counterclockwise by hand if the motor is removed.
- The 700 Series controllers send commands to the motor for camshaft movement. However, water pressure/flow are required during the regeneration cycle for backwash, purge and refill, and brine draw to actually take place.
- Make sure control power source is plugged in. The transformer should be connected to a non-switched power source.
- You can start programming at the beginning by resetting the control mode. When viewing H0 (History Value) push and hold SET for five seconds. The display reverts back to 255 and any programmed information is lost. Return to *700 Series Initial Power Up*.

742/762 SERIES ADVANCED PROGRAMMING

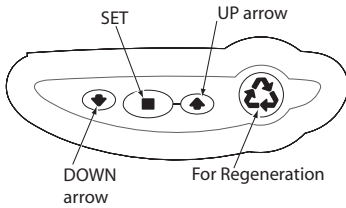

The 700 Series controllers are designed to operate by only setting the time of day and the day of the week. The remaining settings have been set at the factory. These default settings will work for most applications.

To change a setting:

Action	Key	Duration	Display
Enter basic programming	SET	Press and Release	Will show time and day of week
Move to desired display	UP or DOWN arrows	Press and Release	Will increment through the displays
Enable setting to be changed	SET	Press and Release	Display will flash
Change setting	UP or DOWN arrows	Press and Release	Value changes and continues to flash
Save setting	SET	Press and Release	Display stops flashing
Return to operation	REGEN	Press and Release	Normal operation display
View history values	SET and DOWN	Press and Hold for 5 seconds	HO will be displayed
Level II Advanced Programming	UP and DOWN	Press and Hold for 5 seconds	P1 will be displayed

742/762 Level II Professional Programming

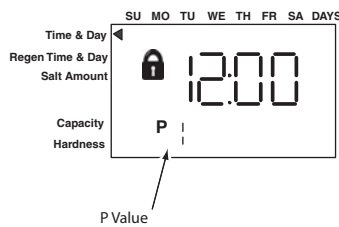

The 742/762 features a special programming level that allows the installing dealer to make changes to the control for more demanding applications. The home owner/end user should never have to access this level.

To enter Level II programming press and hold UP and DOWN for 5 seconds. A "P" value will be displayed indicating Level II.

Level II menus include:

P1 = Time of day

P2 = Day of week

P3 = Time of regeneration

P4 = Number of days between regeneration (99 day calendar override)

P5 = Not used (742 only)

P6 = Amount of regenerant used per regeneration or filter backwash time (salt setting)

P7 = System capacity

P8 = Hardness

P9 = Units of measure

P10 = Clock mode

P11 = Service interval

P12 = Remote regeneration switch delay

P13 = Refill sensor control (conditioner only)

0 = Off

1 = Salt detector only

2 = Chlorine generation

P14 = Refill rate (conditioner only)

P15 = Draw rate (conditioner only)

P16 = Reserve type

P17 = Initial average or fixed reserve

P18 = Flow sensor select

P19 = K-factor or pulse equivalent

Pr = Refill First option

Pd = Remote switch operation (742 only)

See the Logix Professional dealers manual for further details on setting Level II parameters.

Accessing History Values

The 742/762 features a review level that displays the operation history of the system. This is a great troubleshooting tool for the control valve.

To access history values, press and hold SET and DOWN for five seconds to view the "H" levels.

History Values

	Description	Range	Notes
H0	Initial setting value	Cubic feet or liters	Resin volume
H1	Days since last regeneration	0 – 255	
H2	Current flow rate	Depends on turbine used	762 only
H3	Water used today in gallons/m ³ since Time of Regeneration	0 – 131,070 gallons or 0 – 61,310.70 m ³	762 only
H4	Water used since last regeneration in gallons/m ³	0 – 131,070 gallons or 0 – 61,310.70 m ³	762 only
H5	Total water used since reset in 100s	0 – 999,900 gallons or 0 – 9,999 m ³	762 only
H6	Total water used since reset in 1,000,000	4,294 x 10 ⁶ gal or 4,264 x 10 ⁴ m ³	762 only
H7	Average usage for Sunday in gallons or m ³	0 – 131,070 gallons or 0 – 61,310.70 m ³	762 only
H8	Average usage for Monday in gallons or m ³	0 – 131,070 gallons or 0 – 61,310.70 m ³	762 only
H9	Average usage for Tuesday in gallons or m ³	0 – 131,070 gallons or 0 – 61,310.70 m ³	762 only
H10	Average usage for Wednesday in gallons or m ³	0 – 131,070 gallons or 0 – 61,310.70 m ³	762 only
H11	Average usage for Thursday in gallons or m ³	0 – 131,070 gallons or 0 – 61,310.70 m ³	762 only
H12	Average usage for Friday in gallons or m ³	0 – 131,070 gallons or 0 – 61,310.70 m ³	762 only
H13	Average usage for Saturday in gallons or m ³	0 – 131,070 gallons or 0 – 61,310.70 m ³	762 only
H14	Average service cycle	0 - 255 days	762 only
H15	Peak flow rate	0 - 200 gpm or 1,000 Lpm	762 only
H16	Day and time of peak flow rate	Time and day that peak flow occurred	762 only
H17	Months since service	0 - 2,184 months	
Hr	Number of regenerations since last serviced	0-65,536	

Resetting the Control

To reset the control:

1. Press and hold SET and DOWN simultaneously for 5 seconds.
2. H0 and the system's set resin volume (or "F" mode) will be displayed.
3. If a history value other than "H0" is displayed, use the UP button to scroll through the settings until "H0" is displayed.
4. To reset the control, press and hold SET for 5 seconds.
5. The control will be reset to an unprogrammed state.
6. Go to "Initial Set-up" section to reprogram control.



WARNING: Resetting the control will delete all information stored in its memory, except time and day. This will require you to reprogram the control completely from the initial power-up mode.

All further advance programming or set-up instructions can be found in the Dealer Installation and Service Manual, P/N 1255652.

PARTS AND ACCESSORIES

Performa Exploded View

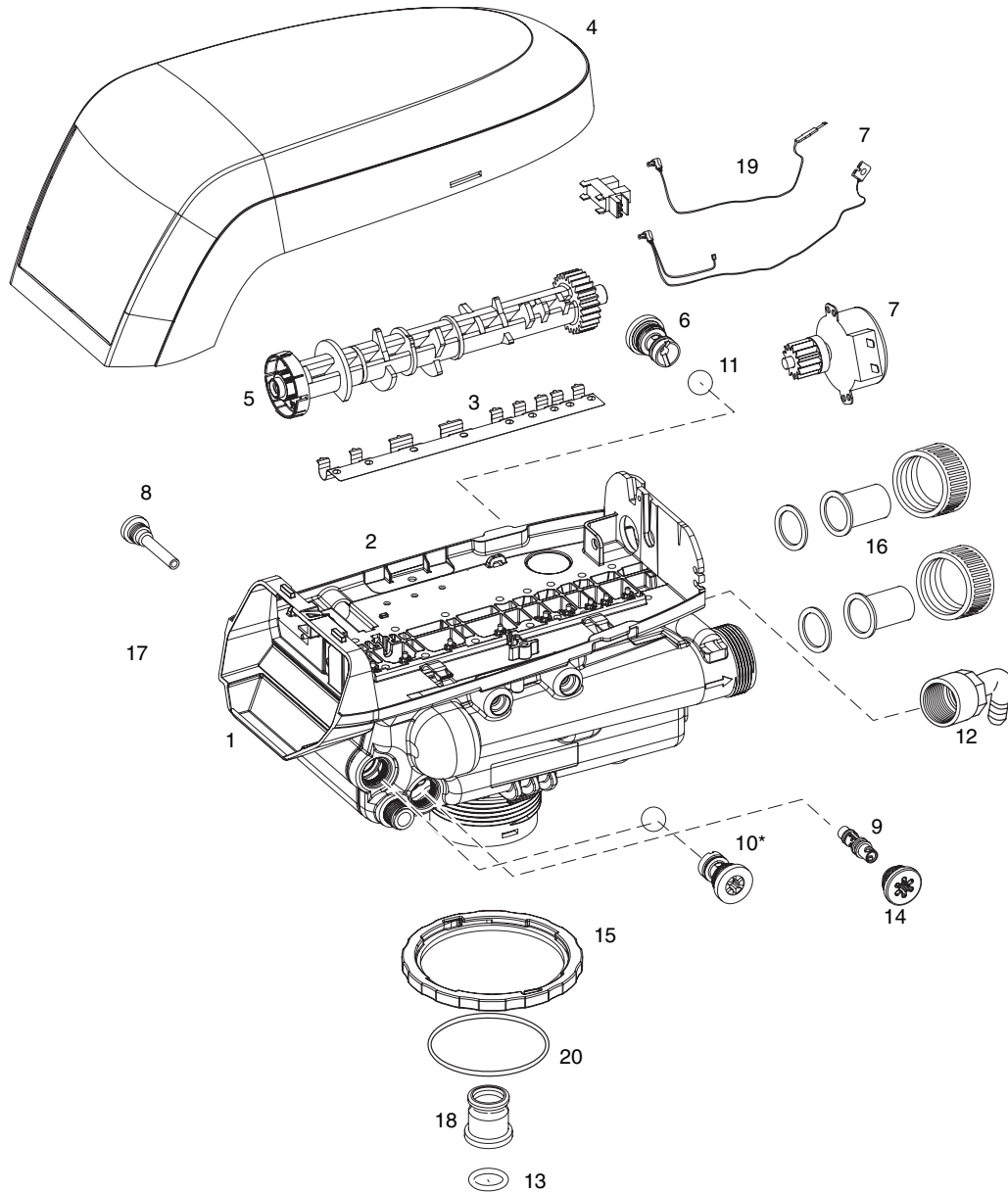

*Warning: Do not use the flow control ball with #10A.

Performa Parts List

Part				Part			
Code	No.	Description	Qty.	Code	No.	Description	Qty.
1	1244652	Valve Assembly w/o Flow Controls	1	10	1000519	Regenerant Refill Controller, 0.13 gpm	1
2	1235338	Top Plate, 268/700 Series Valves	1		1000222	Regenerant Refill Controller, 0.33 gpm	
3	1235339	Valve Disc Spring, One Piece, Performa Valve	1		1000224	Regenerant Refill Controller, 0.74 gpm	
4	1267806	Cover, Valve, Performa 700 Series Controller, Almond	1	11	1030502	Ball, Flow Control	1
5		Performa Logix Camshafts	1	*	1030334	Plugged Refill Flow Control - for 273 Valve	
	1237403*	Cam, 273/700 Series Valve, STD, Gray		12	1002449	Drain Fitting Elbow (3/4-inch hose barbed)	1
	1237405*	Cam, 278/700 Series Valve, STD, Brown		13	1010428	O-Ring	1
6		Drain Control Assembly:	1	14	1000269	Injector Cap with O-Ring	1
	1000209	No. 7 (1.3 gpm; 4.9 Lpm)		15	1035622	Tank Ring	1
	1000210	No. 8 (1.7 gpm; 6.4 Lpm)		*	1041174	Valve Disc Kit: Standard	
	1000211	No. 9 (2.2 gpm; 8.3 Lpm)		16		Plumbing Adapter Kits:	1
	1000212	No. 10 (2.7 gpm; 10.2 Lpm)			1001606	3/4-inch Copper Tube Adapter Kit	
	1000213	No. 12 (3.9 gpm; 14.76 Lpm)			1001670	1-inch Copper Tube Adapter Kit	
	1000214	No. 13 (4.5 gpm; 17 Lpm)			1001608	22-mm Copper Tube Adapter Kit	
	1000215	No. 14 (5.3 gpm; 20 Lpm)			1001613	3/4-inch CPVC Tube Adapter Kit	
	1239760	Blending Valve Kit 900/700 Series Top Plate Drain Line Flow Control (External)			1001614	1-inch CPVC Tube Adapter Kit	
*	1030355	Drain Line Flow Control, 5 gpm (19 Lpm)			1001615	25-mm CPVC Tube Adapter Kit	
	1030356	Drain Line Flow Control, 6 gpm (22.5 Lpm)			1001769	3/4-inch NPT Plastic Pipe Adapter Kit	
	1030357	Drain Line Flow Control, 7 gpm (26.5 Lpm)			1001603	1-inch NPT Plastic Pipe Adapter Kit	
	1030358	Drain Line Flow Control, 8 gpm (30 Lpm)			1001604	3/4-inch BSPT Plastic Pipe Adapter Kit	
	1030359	Drain Line Flow Control, 9 gpm (34 Lpm)			1001605	1-inch BSPT Plastic Pipe Adapter Kit	
	1030360	Drain Line Flow Control, 10 gpm (38 Lpm)			1001611	3/4-inch BSPT Brass Pipe Adapter Kit	
7	1235361	Motor/Optical Cable Assembly	1		1001610	1-inch NPT Brass Pipe Adapter Kit	
8	1000226	Screen/Cap Assembly w/ O-Ring	1		1001612	1-inch BSPT Brass Pipe Adapter Kit	
9		Injector (High Efficiency) Options	1	17	1235373	Module, Sensor, Photo Interrupter	1
	1035736	"L" Injector (High Efficiency) - Orange (13 & 14-inch tanks)		18	1001986	13/16 inch Rubber Insert (Optional)	1
	1035737	"M" Injector - Brown 16-inch Tanks		19	1235446	Turbine Cable	1
	1035738	"N" Injector - Green 18-inch Tanks		20	1010154	Tank O-Ring	1
	1035884	"R" Injector - Dark Grey 21-inch Tanks		*	1033444	Internal Turbine Meter	
	1032978	Plugged Injector for 273 Filter		*	1233187	Motor Locking Pin	
	1032985	Plugged Injector Cap		*	1299336	Chlorine Generator Kit	
				*	1033444	Turbine Assembly	
				*	1041174	Valve Disc Kit, Standard	
				*	1239979	Cable Harness, Remote Regen 742F	
				*	1239711	Switch Kit, Front Mount, 0.1 amp	
				*	1239752	Switch Kit, Front Mount 5 amp	
				*	1239753	Switch Kit, Top Plate Mount, 0.1 amp	
				*	1239754	Switch Kit, Top Plate Mount, 5 amp	

*Not shown on drawing.

Logix 700 Series Controllers Parts List

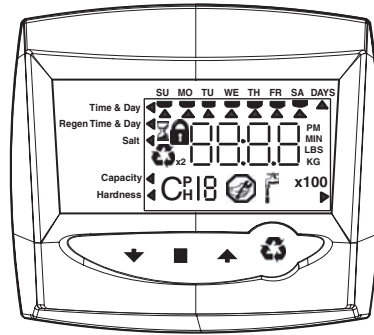

742/762 Control

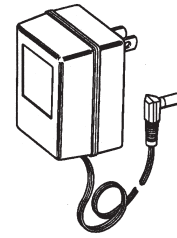

AC Adapter

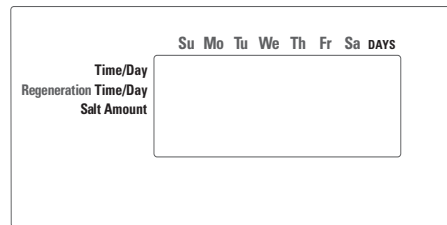

700 Control Overlays

Part			Part				
Code	No.	Description	Qty.	Code	No.	Description	Qty.
		Electronics Modules/Controllers	1			AC Adapter	
1242150		Logix 742 Controller		1000810		Japanese	
1242162		Logix 742 F Controller		1000811		North American	
1242168		Logix 762 Controller		1000812		Australian	
1242170		Logix 762F Controller		1000813		British	
		Electrical Components		1000814		European	
1235361		Motor/Optical Cable Assembl		1030234		Transformer Extension Cord 15 foot (4.5m)	
1235373		Module, Sensor, Photo Interrupter		1235448		North American Outdoor AC Adapter	
1235361		Motor w/Spacer & Pinion				Overlays	
1244336		Refill Sensor Probe for Salt Detector		1238472		Overlay, 716 Controller, English	
		Applications		1238476		Overlay, 740C/742C Controller, English	
1256257		Remote Mount Kit					

TROUBLESHOOTING

700 Series Controller Troubleshooting

Problem	Possible Cause	Solution
ERR 1 is displayed	Controller power has been connected and the control is not sure of the state of the operation.	Press the UP arrow and the control should reset.
ERR 2 is displayed	Controller power does not match 50 or 60 Hz.	Disconnect and reconnect the power. If problem persists, obtain the appropriate controller or AC adapter for either 50 or 60 Hz power.
ERR 3 is displayed	Controller does not know the position of the camshaft. Camshaft should be rotating to find Home position.	Wait for two minutes for the controller to return to Home position. The hourglass should be flashing on the display indicating the motor is running.
	Camshaft is not turning during ERR 3 display.	Check that motor is connected. Verify that motor wire harness is connected to motor and controller module. Verify that optical sensor is connected and in place. Verify that motor gear has engaged cam gear. If everything is connected, try replacing in this order: <ul style="list-style-type: none"> —Wire harness —Motor —Optical sensor —Controller
	If camshaft is turning for more than five minutes to find Home position:	Verify that optical sensor is in place and connected to wire. Verify that camshaft is connected appropriately. Verify that no dirt or rubbish is clogging any of the cam slots. If motor continues to rotate indefinitely, replace the following components in this order: <ul style="list-style-type: none"> —Wire harness —Motor —Optical sensor —Controller
Four dashes displayed: — — : — —	Power failure occurred	Press SET to reset the time display.

System Troubleshooting

Problem	Possible Cause	Solution
1. Brine tank overflow.	<ul style="list-style-type: none"> a. Uncontrolled brine refill flow rate. b. Air leak in brine line to air check. c. Drain control clogged with resin or other debris. 	<ul style="list-style-type: none"> a. Remove brine control to clean ball and seat. b. Check all connections in brine line for leaks. Refer to instructions. c. Clean drain control.
2. Flowing or dripping water at drain or brine line after regeneration.	<ul style="list-style-type: none"> a. Valve stem return spring weak. b. Debris is preventing valve disc from closing. 	<ul style="list-style-type: none"> a. Replace spring. (Contact dealer.) b. Remove debris.
3. Hard water leakage after regeneration.	<ul style="list-style-type: none"> a. Improper regeneration. b. Leaking of external bypass valve. c. O-ring around riser pipe damaged. d. Incorrect capacity. 	<ul style="list-style-type: none"> a. Repeat regeneration after making certain correct salt dosage was set. b. Replace bypass valve. (Contact dealer.) c. Replace O-ring. (Contact dealer.) d. Verify appropriate salt amount and system capacity. (Contact dealer.)
4. Control will not draw brine.	<ul style="list-style-type: none"> a. Low water pressure. b. Restricted drain line. c. Injector plugged. d. Injector defective. e. Valve disc 2 and/or 3 not closed. f. Air check valve prematurely closed. 	<ul style="list-style-type: none"> a. Make correct setting according to instructions. b. Remove restriction. c. Clean injector and screen. d. Replace injector and cap. (Contact dealer.) e. Remove foreign matter from disc and check disc for closing by pushing in on stem. Replace if needed. (Contact dealer.) f. Put control momentarily into brine refill, C8. Replace or repair air check if needed. (Contact dealer.)
5. Control will not regenerate automatically.	<ul style="list-style-type: none"> a. AC adapter or motor not connected. b. Defective motor. 	<ul style="list-style-type: none"> a. Connect power. b. Replace motor. (Contact dealer.)
6. Control regenerates at wrong time of day.	<ul style="list-style-type: none"> a. Controller set incorrectly. 	<ul style="list-style-type: none"> a. Correct time setting according to instructions.
7. Valve will not draw brine.	<ul style="list-style-type: none"> a. Low water pressure. b. Restricted drain line. c. Injector plugged. d. Injector defective. e. Air check valve closes prematurely on 255 valve or brine pickup tube. 	<ul style="list-style-type: none"> a. Set pump to maintain 20 psi at softener. b. Change drain to remove restriction. c. Clean injector and screen. d. Replace injector. (Contact dealer.) e. Put control momentarily into brine/slow rinse, C2. Replace or repair air check if needed. (Contact dealer.)

8. System using more or less salt than regenerant setting.	<ul style="list-style-type: none"> a. Foreign matter in valve causing incorrect flow rates. 	<ul style="list-style-type: none"> a. Remove brine control and flush out foreign matter. Advance control to brine/slow rinse, C2 to clean valve (after so doing position control to "fast rinse, C7" to remove regenerant from tank).
9. Intermittent or irregular regenerant draw.	<ul style="list-style-type: none"> a. Low water pressure. b. Defective injector. 	<ul style="list-style-type: none"> a. Set pump to maintain 20 psi at conditioner. b. Replace injector. (Contact dealer.)
10. No conditioned water after regeneration.	<ul style="list-style-type: none"> a. No regenerant in regenerant tank. b. Injector plugged. c. Air check valve closes prematurely. 	<ul style="list-style-type: none"> a. Add regenerant to regenerant tank. b. Clean injector and screen. c. Put control momentarily into brine/slow rinse, C2. Replace or repair air check if needed. (Contact dealer.)
11. Backwashes or purges at excessively low or high rate.	<ul style="list-style-type: none"> a. Incorrect drain controller used. b. Foreign matter affecting valve operation. 	<ul style="list-style-type: none"> a. Replace with correct size controller. (Contact dealer.) b. Remove drain controller and clean ball and seat.
12. No water flow display when water is flowing on 760 controller.	<ul style="list-style-type: none"> a. Bypass valve in bypass. b. Meter probe disconnected or not fully connected to meter housing. c. Restricted meter turbine rotation due to foreign material in meter. 	<ul style="list-style-type: none"> a. Shift bypass valve to not-in-bypass position. b. Fully insert probe into meter housing. c. Remove meter housing, free up turbine and flush with clean water. Turbine should spin freely. If not, replace meter. (Contact dealer.)
13. Run out of conditioned water between regenerations.	<ul style="list-style-type: none"> a. Improper regeneration. b. Incorrect regenerant setting. c. Incorrect hardness or capacity settings. d. Water hardness has increased. e. Restricted meter turbine rotation due to foreign material in meter. 	<ul style="list-style-type: none"> a. Repeat regeneration, making certain that correct regenerant dosage is used. b. Set P6 to proper level. See salt setting chart. c. Set to correct values. See Programming section. d. Set hardness to new value. See Programming section. e. Remove meter housing, free up turbine and flush with clean water. Turbine should spin freely; if not, replace meter. (Contact dealer.)
14. Regenerant tank overflow.	<ul style="list-style-type: none"> a. Regenerant valve disc 1 being held open by foreign matter. b. Valve disc 2 not closed during regenerant draw causing brine refill. c. Air leak in regenerant line to air check. d. Improper drain control for injector. e. Drain control clogged with resin or other debris. 	<ul style="list-style-type: none"> a. Manually operate valve stem to flush away obstruction. b. Flush out foreign matter holding disc open by manually operating valve stem. c. Check all connections in regenerant line for leaks. Refer to instructions. d. Too small of a drain control with a larger injector will reduce draw rates. e. Clean drain control.

